

Now equipment has become so important that it is essential to our life. We need to select energy efficient devices and systems in order to use them with the minimum possible energy consumption. Additionally, exercising ingenuity in equipment planning that best suits the lifestyles of occupants and building performance can further enhance the use of equipment technology, contributing to increased comfort.

5

Chapter 5 : Energy-efficient Equipment Technology

5

Chapter 5
Energy-efficient
Equipment Technology
(Elemental Technology
Application Method 3)

5.1 Cooling System Planning for Zone VI

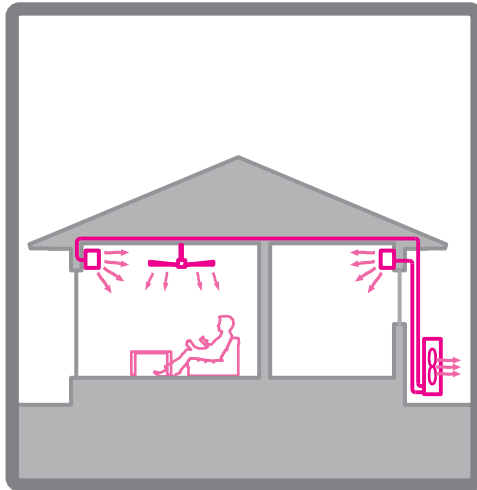

Cooling accounts for an important segment of energy consumption of a household located in a hot humid region (Zone VI). Applying energy-efficient technologies when planning a cooling system is therefore worthwhile.

Planning and designing a cooling system based on the concept of energy efficiency requires that we select a high-efficiency air conditioner with appropriate cooling capacity and consider installing an electric fan or ceiling fan.

5.1.1 Purpose and Key Points of Cooling System Planning

- It is not uncommon in a typical home nowadays to experience difficulty in maintaining a cool temperature only with solar shading or cross ventilation during the height of summer. Cooling systems are therefore becoming an important method to provide protection from heat.
- The indoor thermal environment created by a cooling system and the system's energy consumption vary depending on factors such as weather conditions, the solar shading performance of the building, the amount of internal heat generation, and the use of the cooling system, electric and ceiling fans by the occupants. The use of wind also influences the reduction of cooling energy consumption.
- When selecting a cooling system, consideration should be given to systems possessing high energy consumption efficiency with appropriate cooling capacity based on the solar shading performance of the building as well as the size of the room.
- Electric and ceiling fans help reduce the cooling energy consumption by making it possible to set a slightly higher cooling temperature and creating an indoor airflow to reduce the use of cooling systems.

5.1.2 Energy Conservation Target Levels for Cooling System Planning

1. Definition of target levels

- This document sets targets for individual cooling with an air conditioner.
- Energy conservation target levels for cooling systems are divided into Level 1 to Level 4 as seen below. These levels indicate the reduction rate of the energy consumption of a cooling system.

Level 0	: Cooling energy reduction rate	None
Level 1	: Cooling energy reduction rate	Approx. 10%
Level 2	: Cooling energy reduction rate	Approx. 20%
Level 3	: Cooling energy reduction rate	Approx. 25%
Level 4	: Cooling energy reduction rate	Approx. 35%

- In 2000, the typical cooling energy consumption was 10.3 GJ (approximately 16% of total energy consumption; see Section 6.1 on p.339).
- Any target level can be achieved by adopting the cooling system planning methods.

2. How to achieve target levels

- This document provides the following two methods as cooling system planning methods that can achieve energy saving effects.

Method 1	: Installing high-efficiency air conditioners
Method 2	: Using electric and ceiling fans

- Method 1 makes use of a device (air conditioner) with a high COP (energy consumption efficiency). Method 2 uses electric or ceiling fans making it possible to shorten the time the air conditioner is in use and raise the set temperature of the air conditioner. Any target level for cooling system planning can be achieved by combining these two methods (Table 1).
- The cooling energy reduction effect of using both an air conditioner and electric and ceiling fans depends on the amount of “reduction in power consumed by the air conditioner” and “increase in power consumed by the electric and ceiling fans”. The cooling energy reduction rate shown on Table 1 using Method 2 is based on the calculation that assumes that the set cooling temperature was raised by 1°C (See Method 2, Section 1. Using electric fans on p.214).

Table 1 Target levels for cooling system planning and how to achieve them

Target level	Energy saving effect (Cooling energy reduction rate)	Method used	
		Method 1	Method 2
Level 0	0	Approx. COP3	Not used
Level 1	Approx. 10%	Approx. COP4	Not used
Level 2	Approx. 20%	Approx. COP3	Used
		Approx. COP5	Not used
Level 3	Approx. 25%	Approx. COP4	Used
Level 4	Approx. 35%	Approx. COP5	Used

* To calculate the cooling energy reduction rate shown in the table above, it was assumed that the models were selected based on the conventional and typical guidelines for selecting the air conditioner's cooling capacity.

- Detailed explanation on these methods will be provided in the Section 5.1.4 Energy Saving Methods in Cooling System Planning.

The energy saving effect is calculated using estimate values obtained from methods such as validation experiments and theoretical calculations based on a family of four.

Cooling System Planning for Zone VI 5.1

Glossary: COP
COP stands for Coefficient of Performance, which is an energy consumption efficiency, the number of which indicates how many times more output (capacity) can be obtained by the input of 1. Larger numbers therefore represent better efficiency.
COP = Capacity (kW) / Power Consumption (kW)
Although Annual Performance Factor (APF) or annual energy consumption efficiency has been displayed in product brochures in recent years, this document uses cooling COP to evaluate energy performance.

5

Chapter 5
Energy-efficient
Equipment Technology
(Elemental Technology
Application Method 3)

5.1.3 Steps for Considering Cooling System Planning and Factors for Selecting Cooling System

1. Steps for considering cooling system planning

Step 1 Considering factors for selecting cooling system

- 1) The solar shading performance of the building envelope
See Section 4.2 Solar Shading Methods for Zone VI on p.164
- 2) Controlling the internal heat generation
See Section 5.5 Lighting System Planning on p.288, and Section 5.6 Adopting High-efficiency Consumer Electronics on p.310
- 3) Adopt the most appropriate model according to the space.

Step 2 Considering installation of high-efficiency air conditioners (Method 1)

- 1) Select a high-efficiency device with appropriate cooling capacity
- 2) Consider the energy-efficiency planning and design
- 3) Consider when the device is in operation

Step 3 Considering use of electric and ceiling fans (Method 2)

- 1) Consider the use of electric fans
- 2) Consider the use of ceiling fans

2. Factors for selecting cooling system

When selecting a cooling system and determining the target level, consideration has to be given to the solar shading performance of the house, the household composition, the number of hours when occupants are at home, and the balance between the level of comfort the occupants desire and the cost.

- 1) The relationship between the cooling system and the solar shading performance of a building envelope
 - Solar-shading measures using the building envelope controls the flow of solar heat coming into the room during the summer months and the in-between seasons. It is therefore considered fundamental to providing protection from heat in hot humid regions and helps significantly to reduce cooling energy consumption. To customize the cooling system plan appropriately, it is thus important to examine the level of the solar shading measures first and consider cooling devices that offer appropriate capacity accordingly. This document uses the M value (a summer solar gain coefficient that takes into account factors such as the effect of adjacent buildings) for solar shading measures. See Section 4.2 Solar Shading Methods for Zone VI for its definition.
- 2) Controlling internal heat generation
 - Controlling the heat generated by consumer electronics, lighting devices, cooking, etc., helps considerably to control the cooling energy consumption and to reduce room temperature. A typical power consumption of a family of four with common consumer electronics and lighting devices is 9.76 kWh/day on average (or 292.8 kWh/month). By room, the living and dining room consumes 5.18 kWh/day, the master bedroom 0.36 kWh/day, children's room (two kids in one room) 1.37 kWh/day, and other rooms 2.85 kWh/day. Using these numbers as a guideline, refer to "5.5 Lighting System Planning" and "5.6 Utilizing High-efficiency Consumer Electronics" when considering ways to control internal heat generation so as to examine the issue from the point of view of controlling the cooling energy consumption as well.
- 3) Adopting most appropriate method according to space
 - In addition to the conventional wall-mounted air conditioner indoor units, there are a variety of other models. Some models such as those that are buried completely into the wall or ceiling do not protrude and may be more suitable for aesthetic reasons that need to be taken into account.
 - In a room with a high or vaulted ceiling, using an air circulator such as a ceiling fan may be an effective way to eliminate warm air that tends to pool around the ceiling.

5.1.4 Energy Saving Methods in Cooling System Planning

Method 1 : Installing high-efficiency air conditioners

- Ordinarily, when cooling with air conditioners, every room in the house including the living and dining room would have an air conditioner each, which is used intermittently and as the need arises.

1. Selecting high-efficiency device with appropriate cooling capacity

- Select an air conditioner that offers the appropriate COP according to the target level. Table 2 shows the maximum cooling capacity of devices deemed appropriate for the room size based on the target level for solar shading (See Section 4.2.2 Energy Conservation Target Levels for Solar Shading Schemes on p.167).
- Using devices in which capacity exceeds requirements results in reduced energy consumption efficiency. This applies to air conditioners as well as other devices.
- Generally, an air conditioner's maximum capacity would be greater when heating than cooling. However, in Zones VI and V, the need for cooling exceeds the need for heating. The maximum cooling capacity is therefore the only target that should be used as a guideline when selecting the device.

Table 2 Maximum cooling capacity as guideline for selecting air conditioner (Unit: kW)

Level of solar shading method	M value Summer solar gain coefficient that factors in the effect of adjacent buildings		6 tatami mats (10 m ²)	8 tatami mats (13 m ²)	10 tatami mats (16 m ²)	14 tatami mats (22 m ²)
	Insulation or vented cavity	Solar reflection				
Level 0	Exceeds 0.135	Exceeds 0.150	3.7	4.9	6.1	8.6
Level 1	0.135	0.150	3.1	4.1	5.1	7.1
Level 2	0.10	0.125	2.6	3.4	4.3	6.0
Level 3	0.08	0.115	2.1	2.8	3.5	5.3
Level 4	0.065 ~ 0.04	0.105 ~ 0.092	1.9 ~ 1.6	2.6 ~ 2.1	3.2 ~ 2.7	4.9 ~ 4.0

- It is well known that COP can vary depending on operating conditions such as the load factor (the ratio of output when actually operating and when measuring COP) and the outside air temperature. Fig. 1 shows the relationship based on the measurement results between the load factor, the outside air temperature and COP. COP is highest at around half of the maximum load factor (when the air conditioner's output is at its maximum). When the load factor falls below that point, COP is shown to decrease. Furthermore, the lower the outside air temperature, the higher the COP when cooling. Generally speaking an air conditioner operates at its highest output immediately after starting and operates at a low output otherwise which decreases the COP.

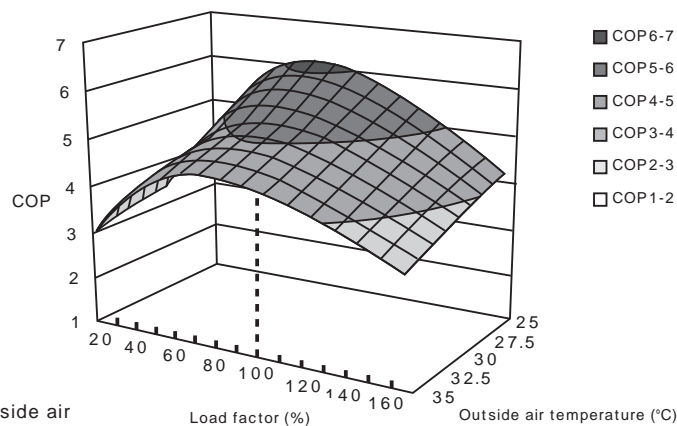

Fig. 1 Relationship between outside air temperature, load factor, and COP

Glossary: "Output" of a cooling system
This refers to the amount of heat that a cooling system removes from the indoor space per hour. Units are measured in kW.

5

- When an air conditioner has been in operation for many hours, the cooling load can become extremely low in the room, resulting in an intermittent operation. COP of an intermittent operation falls even lower than shown in Fig. 1. It is therefore not desirable to operate an air conditioner under low load and intermittent operation conditions from the perspective of taking advantage of the air conditioner's energy-saving performance (high efficiency). If an air conditioner is adopted with a capacity that far exceeds the room's cooling load, the time required to reach a set room temperature is shortened; however, the amount of the time the air conditioner is operating at an inefficient low output increases. Fig. 2 shows test results for the effect that operating with a load factor of less than 50% has on average COP throughout the cooling period (seasonal COP). Using the same device, the lower the ratio of low-output operation, the better the seasonal COP.

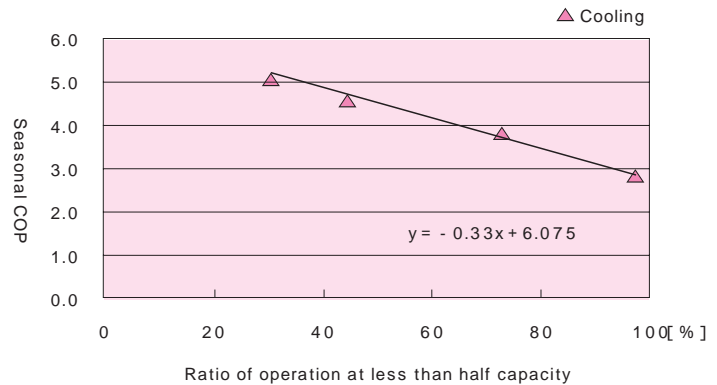

Fig. 2
Effect of ratio of low-load
operation on seasonal COP

2. Considerations for energy conservation planning and designing

- If the outdoor unit is exposed to a direct sunlight, it can reach a high temperature, which in turn causes the COP to worsen when cooling. It is therefore desirable to place the outdoor unit in the shade; however, if it is not possible to do so, an awning may be installed. As the awning must not block the ventilation of the outdoor unit, its shape and the position should be carefully considered.
- If the roof or the outside wall is heated by sunlight, not only does it cause the increase of the cooling load, it also increases thermal sensation, thereby causing discomfort. The discomfort can be alleviated by implementing solar shading measures in the envelope.
- Careful attention needs to be paid during construction to avoid flooding through piping sleeves during typhoons or strong wind and rain. Furthermore, in regions adjacent to the sea, possible salt damage needs to be taken into account. Commercially available outdoor units with salt-damage protection may be used.

3. Considerations during operation

- Raising the set temperature of the air conditioner by 1°C will cut energy consumption by more than 15% (Fig. 3).

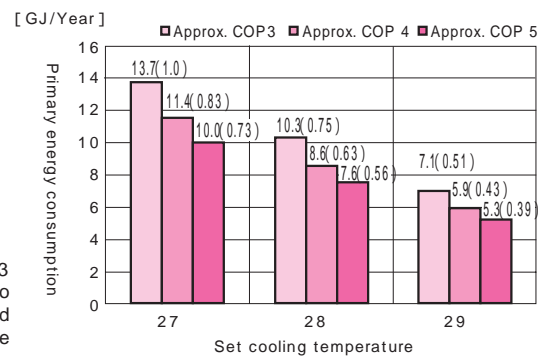

Fig. 3
Cooling energy consumption according to
different air conditioner performance and
set cooling temperature

- Using cross ventilation can limit the increase in room temperature by eliminating the indoor heat and releasing it outdoors. It also stimulates air circulation, which makes one feel cooler.
- A clogged filter reduces the amount of airflow from the air conditioner, which ultimately leads to a lower COP. It is therefore essential to frequently clean the filter to keep the operation efficient. Some commercially available models now come equipped with a self-cleaning function.

Key Point

The importance of selecting air conditioner appropriate for load

- Fig. a Comparison of efficiency between conventional and energy-efficient air conditioners shows the relationship between the outside air temperature (the cooling load varies depending on the outside air temperature) and the COP of a conventional air conditioner (COP≈3) and an energy-efficient air conditioner (COP≈6) measured during the summer months using actual units placed in a living room. This figure confirms the energy saving effect of an energy-efficient device.
- Fig. b Comparison of efficiency between living room and bedroom shows the efficiency of devices with approximately the same COP when one is placed in a living room while the other in a bedroom during the summer months. Although the COPs of both devices are almost identical, it is apparent that the efficiency of the air conditioner placed in the bedroom is lower. It can be presumed that this is caused by the bedroom being located on the north side of the house, thereby creating a comparatively cool (smaller load) environment.
- Fig. c Distribution of load factor shows the amount of output when in operation compared to the device's maximum output (100%) during the summer months. It is shown that, during these months, the air conditioner in the living room operated at approximately half the maximum output while the one in the bedroom was operating merely at 5-20%. In other words, when the capacity of the device far exceeds the load of the room, it can lead to inefficient operation that does not take full advantage of the fact the device itself is efficient. The capacity of the device to be selected therefore needs to be determined with the help of Table 2 and other tools.

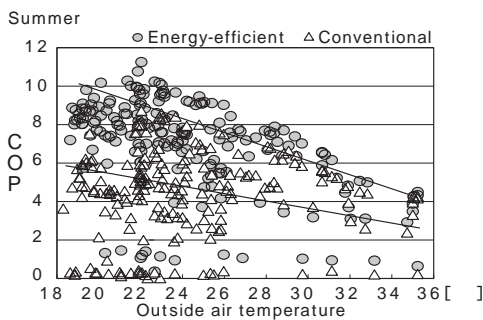

Fig. a Comparison of efficiency between conventional and energy-efficient air conditioners

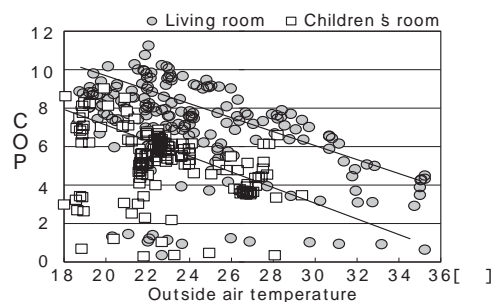

Fig. b Comparison of efficiency between living room and children's room

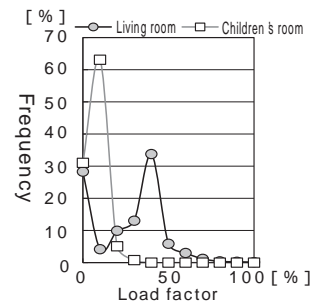

Fig. c Frequency distribution of load factor

Comment Air conditioner's dehumidification function

We are recently seeing many air conditioners with a dehumidification function that employs a method called reheat dehumidification. The traditional dehumidification method had a shortcoming whereby it excessively decreased the room temperature. The reheat dehumidification method, on the other hand, dehumidifies the air by cooling it then

reheats it before releasing it back into the room, which alleviates the discomfort of the dehumidification process. However, it should be noted that the reheat dehumidification operation requires more energy than the conventional dehumidification operation as well as a regular cooling operation.

Method 2 : Using electric and ceiling fans

- Using electric and ceiling fans allows us to set a higher cooling temperature for the air conditioner. Fans also contribute to minimizing the hours required for cooling. It can be expected that setting a higher cooling temperature will result in less consumption of cooling energy.

5

1. Using electric fans

- Electric fans can be useful in limiting the use of cooling as they lower thermal sensation due to a breeze. Occupants can turn on a fan temporarily at a higher setting (high or medium) after returning from work or taking a bath.
- It is still difficult to quantitatively evaluate the cooling sensation created by the airflow of an electric fan. However, even though cooling systems have become commonplace, the energy saving effect of frequently used electric fans cannot be overlooked. The amount of heat removed from the body surface by the airflow varies depending on factors such as the speed of the airflow, the cycle (oscillation cycle, etc.) and the evaporation of sweat.
- Table 3 shows the measured results of the power consumption and the wind speed using two models of electric fans. Model 2 is shown to consume less power yet provides a higher wind speed, which means it is more efficient.

Table 3 Measured results of power consumption and wind speed of electric fans

		Model 1			Model 2		
Rated power consumption (W; 50/60 Hz)		52/53			40/43		
Wind speed setting		Low	Medium	High	Low	Medium	High
Power consumption (W; 50 Hz)	W/ oscillation	40	46	56	24	31	50
	W/O oscillation	37	44	54	23	31	49
Wind speed W/O oscillation (Average value at the top speed; m/s)	At 2 m	1	1.1	1.2	1.2	1.4	2
	At 3 m	0.6	0.7	0.8	1	1.2	1.4
Full oscillation cycle (s)		21.8	18.9	16.4	25.7	20.0	15.3

- From our estimates, it was shown that 1°C in reduction of thermal sensation can be expected when the electric fan is placed at a distance of 2 to 3 m (when used for a long period of time at a low wind speed setting with oscillation). As we can expect to lower the thermal sensation by 1°C and can set the cooling temperature of the air conditioner 1°C higher, using an electric fan along with an air conditioner can be said to have a cooling energy saving effect. On the other hand, if the cooling temperature of the air conditioner remains unchanged when used in conjunction with an electric fan, the energy consumption simply increases for the amount used by the electric fan.

2. Using ceiling fans

- Ceiling fans (Fig. 4) can send airflow to a wider area than electric fans and can have a more general effect in reducing thermal sensation within a room. If the ceiling offers a good height such as a vaulted ceiling where warm air tends to pool, a ceiling fan can limit the increase of the temperature on the ceiling surface by circulating the air as well as reduce the thermal sensation within the area. (However, if the cause of the warm air pooling at the ceiling is weak insulation or solar shading in the roof or attic, using a ceiling fan may increase the cooling energy consumption.)
- Ceiling fans consume approximately the same amount of energy as electric fans but cover a wider area with airflow, which means that they can have a more general effect in the room to reduce the thermal sensation. (When an experiment was conducted with a ceiling fan with a ceiling height of 4.9 m, the wind speed obtained was 0.3 m/s at medium setting and 0.1 to 0.2 m/s at low setting within the area. The wind created at medium setting appears to be sufficient to be felt by occupants.)
- Although ceiling fans can be difficult to install unless the ceiling height is relatively high, more and more products now combine the fan and the lighting to facilitate installation. In terms of safety and other factors, a ceiling height of 2.5 m seems to be the minimum requirement. (The distance between the ceiling surface and the lowest point of the fan can be as small as 20 cm or so depending on the product.)
- We are increasingly seeing fans with simple, modern designs in addition to the conventional classic design, which gives consumers a wide range of selection design-wise.



Fig. 4 Example of ceiling fan

5.1.5 Selecting Auxiliary Heater

- There exist many choices in auxiliary heaters used during the winter months including *kotatsu* (a small quilt-covered table with an electric heater affixed underneath), electric panel heaters, electric space heaters, electric carpets, ceramic heaters, and halogen heaters. Using these devices may consume more power than heat pump air conditioners used for the same period of time.
- Burning an open flame or heating with an unvented heater that releases exhaust into the room reduces the indoor air quality as fuel is burned indoors. Care is therefore required such as avoiding using such heaters for a long period of time and airing the room frequently when in use.

Comment Power consumption of auxiliary heaters

The figure compares the power consumption of an energy-efficient heat pump air conditioner, an electric carpet and a *kotatsu* all placed in a living room (floor area: 24 m²). The heat pump air conditioner may consume a significant amount of power immediately after start-up; however, when the temperature stabilizes, it is shown to consume not much more than the electric carpet or the *kotatsu* at a low

setting. Furthermore, from the point of view of energy efficiency, the low setting is recommended for both the *kotatsu* and the electric carpet. The electric carpet and the *kotatsu* may seem energy efficient, as they are localized heaters; however, if left on for a long period of time, they consume more energy than other heaters that heat the entire room.

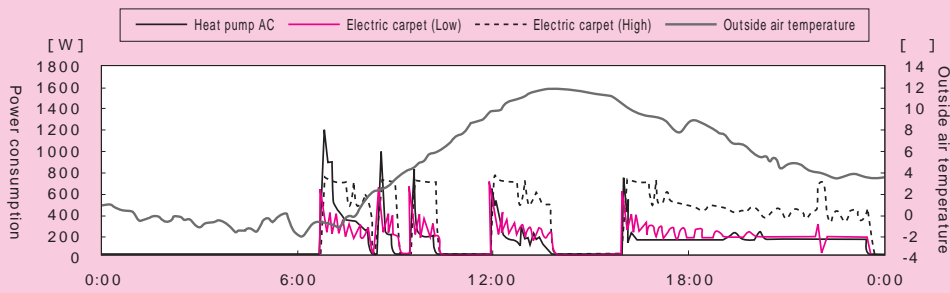

Fig. a Energy consumption comparison between heat pump air conditioner and electric carpet

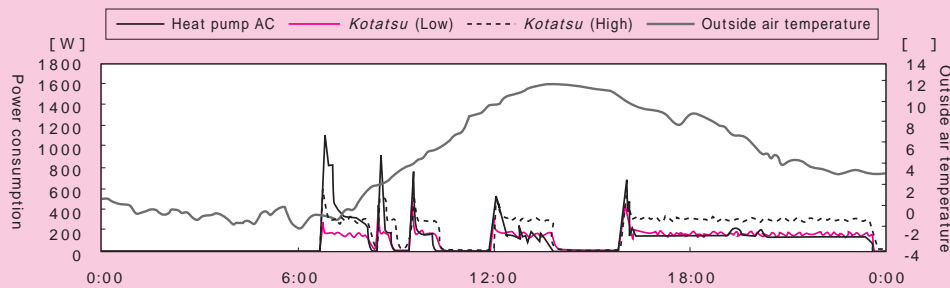

Fig. b Energy consumption comparison between heat pump air conditioner and *kotatsu*

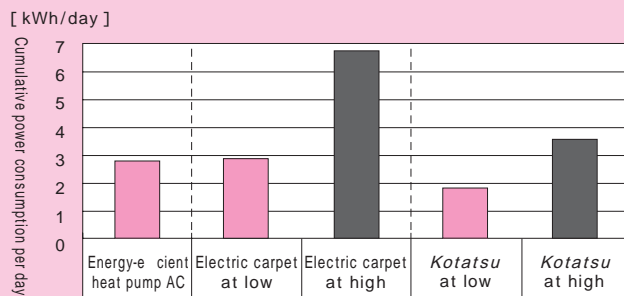

Fig. c Comparison of daily power consumption

Conditions

Building and location: Multi-family residential building in Tsukuba City, Ibaraki Prefecture
 Heat pump AC: Energy-efficient 2.2 kW model (COP≈6)
 Electric carpet: For use for 3-*tatami*-mat area (Area: 5 m²); Rated power consumption: high = 700 W, low = 350 W
Kotatsu: Square-shaped (Each side measures 75 cm: rated power consumption: 600 W)
 The power consumption patterns for the electric carpet and the *kotatsu* were estimated based on the power consumption measured in the artificial climate chamber (outside temperature = 5°C, indoor temperature = 15°C).

5

5.2 Heating and Cooling System Planning for Zone V

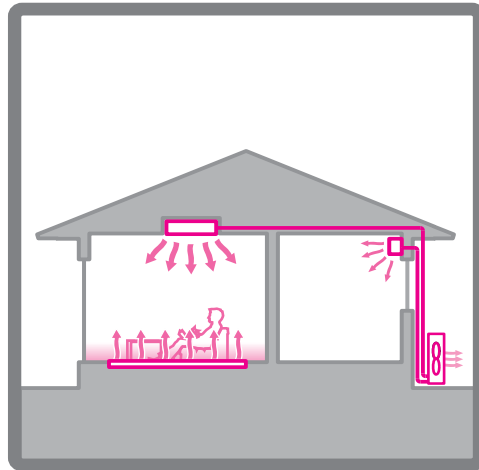

Heating and cooling energy consumption accounts for 15 – 40% of total energy consumption of a household located in a hot humid region (Zone V). Applying energy-efficient technologies when planning a heating and cooling system is therefore worthwhile.

Planning and designing a heating and cooling system based on the concept of energy efficiency requires basic knowledge for selecting and installing appropriate system and devices.

5.2.1 Purpose and Key Points of Heating and Cooling System Planning

- Since it is common in modern houses to experience difficulty in maintaining a comfortable indoor environment only with insulated building envelopes, solar shading or solar heat gain, it requires heating and cooling systems. Energy consumption of heating and cooling systems is significant, making energy saving design in heating and cooling systems important.
- Many different types of heating and cooling system are available for detached houses. When operation methods are categorized according to the area to be heated or cooled, they can be divided into a system in which heating and cooling is controlled room by room, i.e. the partial system, and a system in which heating and cooling is controlled by the whole building, i.e. the whole-building system. There are a range of heating and cooling devices belonging to either of these two categories. Moreover, new devices are being developed frequently.
- According to the classification by the duration of heating and cooling, a system in which heating and cooling is operated while occupants are in each room, i.e. the partial intermittent system, is generally used when heating and cooling is controlled room by room. Meanwhile, when heating and cooling is controlled by the whole building, a system in which heating and cooling is operated 24 hours regardless of occupants being in each room or not, i.e. the whole-building continuous system is used (Table 1).
- The indoor thermal environment created by a heating and cooling system and the system's energy consumption vary depending on factors such as weather conditions, insulation performance of building envelopes, solar shading performance of openings, and the use of the system by occupants (e.g. household composition, number of hours when occupants are at home, operation methods). The utilization of natural energy such as wind and solar heat also influences the reduction of heating and cooling energy consumption.
- Although it is not easy to systematically organize the energy saving design methods for heating and cooling systems, it is important to select a system according to the equipment characteristics and make an energy saving design for the system.

Table 1 Classification of heating and cooling system by operation method

Classification by area to be heated or cooled	Heating and cooling controlled room by room	Partial system
	Heating and cooling controlled by whole building	Whole-building system
Classification by duration of heating and cooling	Heating and cooling operated only when occupants are in each room (heating and cooling not operated when occupants are asleep)	Intermittent system
	Heating and cooling operated 24 hours regardless of occupants being at home or not	Continuous system

Remark Duration of heating and cooling can be roughly categorized as shown above, but various other operation methods are possible, such as turning off heating when sleeping at night or setting heating temperature low while using a continuous system. Any combination of two of the above-mentioned operation methods is also feasible, for example, using a continuous system in living and other major rooms while adopting an intermittent system in bedrooms in which heating and cooling is operated when the occupants are there.

5.2.2 Energy Conservation Target Levels for Heating and Cooling System Planning

1. Types of heating and cooling system discussed in this document

- This document provides information on the following four types of heating and cooling system, both partial intermittent and whole-building continuous systems, which are generally used in homes in hot humid regions (Zone V):
 - 1) Type 1: Heating and cooling air conditioner
 - 2) Type 2: Gas or oil hot water heating
 - 3) Type 3: Forced flue (FF) heating
 - 4) Type 4: Duct central heating and cooling
- Types 1, 2 and 3 are applicable to the partial intermittent system while Type 4 is applicable to the whole-building continuous system.
- Heating and cooling air conditioner (Type 1) and duct central heating and cooling (Type 4) can be used for heating in winter as well as cooling in summer. However, gas and oil hot water heating (Type 2) and FF heating (Type 3) can be used only for heating in winter.
- In this document, gas and oil hot water heating is expected to adopt a partial intermittent system in which floor heating is used for heating the living and dining room only, instead of a whole-building heating system in which heat radiation panels are installed in each habitable room as seen in cold regions. Therefore, a heat pump air conditioner is anticipated to be used in habitable rooms other than the living room, dining room and kitchen.
- Duct central heating and cooling is assumed to adopt a system in which a heat pump is used as a heat source and heating and cooling is performed with electricity.

2. Definition of target levels

- Energy saving methods and effects vary depending on which type of heating and cooling system is used.
- The partial intermittent system (Type 1: heating and cooling air conditioner) and whole-building continuous system (Type 4: duct central heating and cooling) have energy conservation target levels as shown in the table below.
- Of the partial intermittent systems, energy saving effects of hot water heating (Type 2) and FF heating (Type 3) are explained in the next section.

Energy conservation target levels for partial intermittent system (Type 1: heat pump air conditioner)

Level 0	: Heating energy reduction rate	None
Level 1	: Heating energy reduction rate	Approx. 5%
Level 2	: Heating energy reduction rate	Approx. 10%
Level 2	: Heating energy reduction rate	Approx. 15%
Level 3	: Heating energy reduction rate	Approx. 20%
Level 3	: Heating energy reduction rate	Approx. 25%
Level 4	: Heating energy reduction rate	Approx. 30%

Energy conservation target levels for partial intermittent system (Type 1: air conditioner)

Level 0	: Cooling energy reduction rate	None
Level 1	: Cooling energy reduction rate	Approx. 5%
Level 2	: Cooling energy reduction rate	Approx. 10%
Level 2	: Cooling energy reduction rate	Approx. 15%
Level 3	: Cooling energy reduction rate	Approx. 20%
Level 3	: Cooling energy reduction rate	Approx. 25%
Level 4	: Cooling energy reduction rate	Approx. 30%
Level 4	: Cooling energy reduction rate	Approx. 35%

5

Energy conservation target levels for whole-building continuous heating system (Type 4: duct central heating)

Level 0	: Heating energy reduction rate	None
Level 1	: Heating energy reduction rate	Approx. 20%
Level 2	: Heating energy reduction rate	Approx. 45%

Energy conservation target levels for whole-building continuous cooling system (Type 4: duct central cooling)

Level 0	: Cooling energy reduction rate	None
Level 1	: Cooling energy reduction rate	Approx. 25%
Level 2	: Cooling energy reduction rate	Approx. 40%

- In 2000, the typical heating and cooling energy consumption when adopting a partial intermittent system was 5.0 GJ and 5.7 GJ, respectively (approximately 7% and 8% of total energy consumption; see Section 6.1 on p.339).
- In 2000, the typical heating and cooling energy consumption when adopting a whole-building continuous system was 13.4 GJ and 27.0 GJ, respectively (approximately 13% and 27% of total energy consumption; see Section 6.1 on p.339).

3. How to achieve target levels

1) Prerequisites for verifying energy saving effects

Partial intermittent heating and cooling system

- Details and effectiveness of energy saving methods vary depending on the heating system. This document presents the methods that can achieve energy conservation target levels by heating system type.
- Generally, an appropriate capacity of heat source equipment is determined by factors such as the house performance, area of heated room, and duration of heating. If the device capacity selected is much larger than the appropriate capacity, energy saving effects described in this document may not be expected. The higher the radiator capacity of hot water heating (Type 2; heating area in case of floor heating), the greater its performance, which may result in energy saving. Because of this, it is necessary to differentiate the capacity of radiator and that of heat source equipment. See Section 5.2.4 Energy Saving Methods in Heating and Cooling System Planning on p.230 for how to select device capacity.
- Since the heating energy consumption of bedrooms, children's rooms and other habitable rooms is very low compared to that of the living room, dining room and kitchen, the effectiveness of introducing energy saving methods to other habitable rooms is relatively low. This is why this document does not estimate the effectiveness of introducing energy saving methods to other habitable rooms. Therefore, if an appropriate capacity of air conditioner is chosen for the living room, dining room and kitchen, great energy saving effects can be expected.
- This document is written assuming that other habitable rooms are used before and after dinner and before sleeping during the weekdays. However, if other habitable rooms are used for extended periods of time because of being occupied by seniors or other people, energy saving effects become relatively higher, thus it is very effective to introduce high-efficiency air conditioners.
- Energy saving effects shown in this document are calculated with a room temperature set at 28°C in summer and 20°C in winter.

Whole-building continuous heating and cooling system

- Regarding duct central heating and cooling, an appropriate capacity of heat source equipment is generally determined by factors such as the house performance, area of heated room, and duration of heating. If the device capacity selected is much larger than the appropriate capacity, energy saving effects described in this document may not be expected.
- Energy saving effects shown in this document are calculated with a room temperature set at 28°C in summer and 20°C in winter.

2) Target levels for heating and cooling air conditioner and how to achieve them (Type 1)

Heat pump air conditioner

- This document provides the following methods as system planning methods for heat pump air conditioners that can achieve energy saving effects:

Method 1	: Adopting high-efficiency air conditioners
Method 2	: Setting appropriate device capacity

- Method 1 makes use of a device (air conditioner) with a high rated heating efficiency, which is influenced by the rated heating efficiency of air conditioners installed in the living room, dining room and kitchen.
- Method 2 selects an air conditioner with an appropriate capacity according to the insulation performance of the house. Since manufacturers' selection criteria are based on obsolete information on average homes, it is likely to be more energy efficient to choose an air conditioner with a smaller capacity than the value provided in the catalogue for a modern house with good insulation performance. However, if the capacity is too low it is difficult to heat the house with the heat pump air conditioner alone and energy inefficient heaters may also end up being used. This does not save energy, thus careful attention is required when selecting the air conditioner capacity. For details, see Section 5.2.4 Energy Saving Methods in Heating and Cooling System Planning on p.231.
- Table 2 shows the correspondence between energy conservation target levels and methods for heat pump air conditioners. It subdivides the target levels based on the relationship between the methods and heating energy reduction rates.

Table 2 Target levels for heat pump air conditioner (Type 1; partial intermittent system) and how to achieve them

Target level	Energy saving effect (Heating energy reduction rate)	Method used	
		Rated heating efficiency (air conditioner installed in living/dining room/kitchen)	
		Without Method 2	With Method 2
Level 0	0	Below 4.9	
Level 1	Approx. 5%	4.9 or higher	
Level 2	Approx. 10%		Below 4.0
Level 2	Approx. 15%		4.0 or higher
Level 3	Approx. 20%		4.5 or higher
Level 3	Approx. 25%		5.3 or higher
Level 4	Approx. 30%		6.2 or higher

* The device capacity of air conditioner (maximum heating capacity) in the case of "Without Method 2" is estimated as 7.51 kW for living/dining room and kitchen and 3.08 kW for other habitable rooms. In the case of "With Method 2", it is estimated as 3.08 kW for both living/dining room and kitchen and other habitable rooms. Rated heating efficiency for Level 0 is assumed as 3.8.

Air conditioner

- This document presents the following methods as system planning methods for air conditioners that can achieve energy saving effects:

Method 1	: Adopting high-efficiency air conditioners
Method 2	: Setting appropriate device capacity
Method 3	: Using electric or ceiling fans

- Method 1 makes use of a device (air conditioner) with a high rated cooling efficiency.
- Method 2 selects an air conditioner with an appropriate capacity according to the insulation performance of the house (Same as (1) heat pump air conditioner).
- Method 3 makes good use of an electric or ceiling fan when an air conditioner is required. Reducing the thermal sensation by generating airflow in the room allows you to set the air conditioner temperature higher in addition to shortening the duration of cooling devices.

Glossary: Rated efficiency
Rated efficiency is a value of heating and cooling capacity measured under rated conditions that is divided by power consumption at that time. It is expressed as energy consumption efficiency or COP in product catalogues.
As this value increases, less power consumption is required for heating and cooling, thus it is more energy efficient.
Rated conditions refer to test conditions for measuring energy saving performance of air conditioners specified by the Japanese Industrial Standards (JIS).

5

- Energy saving effects of air conditioners vary between the living room, dining room and kitchen and other habitable rooms. Therefore, a sum of the energy saving effect of the living room, dining room and kitchen and other habitable rooms should be calculated according to the following equation:

Energy saving effects of air conditioner

$$= \text{Energy saving effect of living room, dining room and kitchen} + \text{Energy saving effect of other habitable rooms}$$

- Here, we present the correspondence between energy saving effects and methods using air conditioners in the living room, dining room and kitchen and other habitable rooms (Tables 3, 4). Energy conservation target levels for air conditioners are set in a combination of class for the living room, dining room and kitchen and class for other habitable rooms. Table 5 subdivides the target levels based on the relationship between a combination of classes and cooling energy reduction rate.

Table 3 Energy saving effect classes of air conditioner (Living/dining room/kitchen)

Class	Energy saving effect (Cooling energy reduction rate)	Method used (Rated cooling efficiency)			
		Without Method 3		With Method 3	
		Without Method 2	With Method 2	Without Method 2	With Method 2
Class 0	0	Below 3.5		Below 3.0	
Class 1	Approx. 5%	3.5 or higher		3.0 or higher	
Class 2	Approx. 10%	4.3 or higher	Below 3.7	3.7 or higher	Below 3.2
Class 3	Approx. 15%	5.6 or higher	3.7 or higher	4.9 or higher	3.2 or higher
Class 4	Approx. 20%		4.4 or higher		3.9 or higher
Class 5	Approx. 25%		5.3 or higher		4.9 or higher

Table 4 Energy saving effect classes of air conditioner (Other habitable rooms)

Class	Energy saving effect (Cooling energy reduction rate)	Method used (Rated cooling efficiency)			
		Without Method 3		With Method 3	
		Without Method 2	With Method 2	Without Method 2	With Method 2
Class 0	0	Below 3.8	Below 3.7	Below 3.3	Below 3.2
Class 1	Approx. 5%	3.8 or higher	Below 3.7	3.3 or higher	3.2 or higher
Class 2	Approx. 10%	5.1 or higher	Below 4.9	5.0 or higher	4.8 or higher

Table 5 Target levels for air conditioner (Type 1; partial intermittent system) and how to achieve them

Target level	Energy saving effect (Cooling energy reduction rate)	Living/dining room/kitchen class applied		
		When other habitable room class is 0	When other habitable room class is 1	When other habitable room class is 2
Level 0	0	Class 0		
Level 1	Approx. 5%	Class 1	Class 0	
Level 2	Approx. 10%	Class 2	Class 1	Class 0
Level 2	Approx. 15%	Class 3	Class 2	Class 1
Level 3	Approx. 20%	Class 4	Class 3	Class 2
Level 3	Approx. 25%	Class 5	Class 4	Class 3
Level 4	Approx. 30%		Class 5	Class 4
Level 4	Approx. 35%			Class 5

3) Target levels for gas and oil hot water heating and how to achieve them (Type 2)

- This document provides the following methods as system planning methods for gas and oil hot water heating that can achieve energy saving effects:

Method 1	: Adopting high-efficiency heat source equipment
Method 2	: Lowering supply water temperature of heat source equipment
Method 3	: Underfloor and piping insulation and shortening piping length
Method 4	: Adopting floor heating and increasing rate of floor heating area

- Method 1 adopts high-efficiency heat source equipment, i.e. heat source equipment with high energy consumption efficiency (heating output divided by fuel consumption).
- Method 2 involves a device that functions to lower the supply water temperature of heat source equipment.
- Method 3 aims to reduce heat loss by reinforcing the insulation under the floor heating panels on the first floor and insulating hot water piping as well as shortening the piping length.
- Method 4 makes use of floor heating and increases the rate of floor heating area. Floor heating can increase comfort and decrease heating temperature. An increased rate of floor heating area enhances the amount of heat radiation and improves heat source efficiency.
- Table 6 provides the correspondence between energy conservation target levels and methods for gas and oil hot water heating.
- The energy saving evaluation shown in Table 6 is based on air conditioners (see Table 2 on p.219 for standard conditions), and energy consumption is estimated to increase by 15% compared to the standard even when Methods 1 to 4 are adopted. However, radiant heating such as floor heating and panel heating which is also hot water heating, is generally highly recognized for comfort. For that reason, if we are to comprehensively evaluate these hot water heating devices there is no reason for restraining from using them. Having said that, it is recommended to control energy consumption by keeping in mind the characteristics presented in Table 6 and adopting Methods 1 to 4 or to reduce overall energy consumption by adopting other elemental technologies (e.g. energy saving technology related to domestic hot water system).
- Characteristics of the thermal environment created by radiant heating, floor heating in particular, and its energy efficiency are still not completely known and further research and development efforts are required.

Table 6 Target levels for gas and oil hot water heating (Type 2; living/dining room/kitchen) and how to achieve them

Target level	Energy saving effect (Heating energy reduction rate)	Method used	
		Gas heat source	Oil heat source
Level - 4	Approx. 65% increase		Method(s) not adopted
Level - 3	Approx. 40% increase	Method(s) not adopted	All methods adopted
Level - 2	Approx. 15% increase	All methods adopted	

* The calculation is based on a heat source equipment efficiency of 78%, 60 °C hot water supply, sleeve tube piping, and floor heating panels in which 85% of total energy used for floor heating is released in the room as heat. Method 1 is calculated with 83% efficiency of high-efficiency heat source equipment and 60 °C hot water supply. Latent heat recovery gas heat source equipment is used as a low-temperature model for Method 2, which is calculated at 86% efficiency with 40 °C and 60 °C hot water supply. For Method 3, the calculation is based on insulated piping and floor heating panels in which 90% of total energy used for floor heating is released in the room as heat. For piping length, it is assumed that piping is laid from where the heat source equipment is installed near the panels (east of the living/dining room and kitchen). Method 4 is calculated assuming that heating load is reduced by 10%.

5

- 4) Target levels for forced flue (FF) heating and how to achieve them (Type 3)
- This document does not specify the system planning methods for FF heating which are expected to provide energy saving effects. The energy conservation target level for a device with average capacity is shown in Table 7.
 - This target level is set based on the energy consumption of heat pump air conditioners at Level 0, and energy consumption tends to increase compared to heat pump air conditioners.

Table 7 Target levels for FF heating (Type 3; living/dining room/kitchen)

Target level	Energy saving effect (Heating energy reduction rate)	Method used
Level - 1	Approx. 5% increase	Not specified

* The value above is calculated based on the FF heating system for living/dining room and kitchen with a maximum capacity of 4.77 kW, rated efficiency of 86.1%, and rated power consumption of 48W.

Comment Use of electric heaters in other habitable rooms

Bedrooms, children's rooms and other habitable rooms are sometimes heated by electric heaters. Electric heaters are not intended to heat the entire room alone but are often used as portable heating units. Although it depends on the situation, using heat pump air conditioners in the living room, dining room and kitchen and electric heaters in all other habitable rooms increases heating energy consumption by

approximately 40% compared to level 0 (standard level of heat pump air conditioners).

Converting electric energy directly into heat energy without heat pump technology is the least efficient, and the use of electric heaters should be avoided as much as possible (See Section 5.2.5 Selecting Auxiliary Heater on p.243 for details).

Comment Use of unvented heaters

Heaters are divided into two types—unvented and vented—according to the way it burns kerosene, processed natural gas and other fuels. Heaters take the air into the inside to burn the fuel to generate heat. Unvented heaters release the combustion gas generated during this process into the room while vented heaters directly release it outside.

When an unvented heater is used, indoor air pollutants, including nitrogen dioxide and carbon dioxide, which may cause health hazards to the occupants (toxicity of carbon dioxide becomes an issue when the concentration exceeds 3,500 ppm), are emitted depending on the fuel composition. Because of this, a large amount of ventilation is required, but it is hardly performed in reality since it is difficult

to achieve this level of ventilation. As a result, unvented heater can be a source of indoor air pollutants.

For your reference, the amount of ventilation required per unit heat generation (1 kW) is approximately 90 m³/h for regular processed natural gas and approximately 185 m³/h for kerosene (source: Materials on Symposium about HASS102-1995 Ventilation Standard, The Society of Heating, Air-Conditioning and Sanitary Engineers of Japan).

Moreover, a large amount of vapor generated from fuel combustion is a major cause of condensation, which tends to soil the interior finish and promote mold growth. Unvented heaters should be avoided from this perspective as well.

- 5) Target levels for duct central heating and cooling and how to achieve them (Type 4; whole-building continuous system)
- This document presents the following methods as system planning methods for duct central heating and cooling that can achieve energy saving effects:

Method 1 : Adopting high-efficiency central heating and cooling system (at least 4.0 of rated cooling efficiency)

Method 2 : Adopting model with room-by-room temperature control function

- Tables 8 and 9 show the correspondence between energy conservation target levels and methods for duct central heating and duct central cooling, respectively.

Table 8 Target levels for duct central heating and how to achieve them (Type 4)

Target level	Energy saving effect (Heating energy reduction rate)	Method used
Level 0	0	No method adopted
Level 1	Approx. 20%	Method 1
Level 2	Approx. 45%	Method 1 + Method 2

* A central heating system with a rated heating capacity of 8 kW and rated consumption of 2.54 kW (equivalent of COP3) is used. Method 1 estimates a high-efficiency central heating and cooling system of the similar capacity with an energy consumption efficiency close to COP4. The temperature control function of Method 2 is calculated with heating temperature at 16 °C when the occupants are either not in the room or are sleeping.

Table 9 Target levels for duct central cooling and how to achieve them (Type 4)

Target level	Energy saving effect (Cooling energy reduction rate)	Method used
Level 0	0	No method adopted
Level 1	Approx. 25%	Method 1
Level 2	Approx. 40%	Method 1 + Method 2

* A central cooling system with a rated cooling capacity of 7.1 kW and rated consumption of 2.36 kW (approx. COP3.1) is used. Method 1 estimates a high-efficiency central heating and cooling system of the similar capacity with an energy consumption efficiency close to COP4. The temperature control function of Method 2 is calculated with cooling temperature at 30 °C when the occupants are either not in the room or are sleeping.

5

Chapter 5 Energy-efficient
Equipment Technology
(Elemental Technology
Application Method 3)

5.2.3 Steps for Considering Heating and Cooling System Planning

1. Steps for considering heating and cooling system planning

Step 1 Checking prerequisites

- Weather conditions
- Insulation performance of building envelopes
See Section 4.1 Insulated Building Envelope Planning for Zone V on p.124
- Ventilation system types and other factors
See Section 5.3 Ventilation System Planning on p.244
- Household composition

Step 2 Considering how to operate (duration and place) heating and cooling system

- Duration of heating and cooling
...Intermittent or continuous system
- Place of heating and cooling
...Partial system (heating only the room being occupied)
Whole building system (heating the entire house)

Step 3 Considering types of heating and cooling system

- Select types of heating and cooling system
Type 1: Heating and cooling air conditioner
Type 2: Gas or oil hot water heating
Type 3: Forced flue (FF) heating
Type 4: Duct central heating and cooling
- Consider the use of auxiliary heaters (avoid as much as possible or limit to short-term use)
- Consider the use of natural wind and auxiliary cooling (electric and ceiling fans)

Step 4 Examining energy saving methods for heating and cooling system planning

- 1) Examine energy saving methods
(Select appropriate heating and cooling capacity and high-efficiency equipment)
- 2) Consider the energy efficiency planning and design
- 3) Consider the operating system
(See Section 5.2.4 Energy Saving Methods in Heating and Cooling System Planning on p.230)

Step 5 Consider methods for utilizing auxiliary heaters

(See Section 5.2.5 Selecting Auxiliary Heater on p.243)

5

Chapter 5 Energy-efficient Equipment Technology (Elemental Technology Application Method 3)

- On the other hand, the partial intermittent system causes a temperature difference between the heated or cooled room and the unheated or uncooled room. This system provides inferior comfort particularly in winter when hallways and washing rooms become extremely colder compared to the living room or kitchen.
- In actual houses, it is possible to create an intermediate system between the whole-building system and the partial system by increasing the insulation performance and using ingenuity in creating ventilation paths and room plans to heat and cool the living room and kitchen, which allows the hallways and washing rooms to be moderately heated and cooled as well. Design ingenuity creates a possibility of overcoming the disadvantages of both systems in terms of running costs and comfort.
- The insulation performance of the entire house needs to be increased so that the thermal environment of unheated space including hallways, stairs, washing rooms and toilets is not significantly different from that of heated rooms. Table 10 shows the temperature differences between heated rooms (living and dining rooms) and unheated rooms (washing room, first floor toilet and bedrooms) of a house during the heating period (January and February). The greater the insulation level, the higher the room temperature and the lower the temperature difference of the unheated rooms.

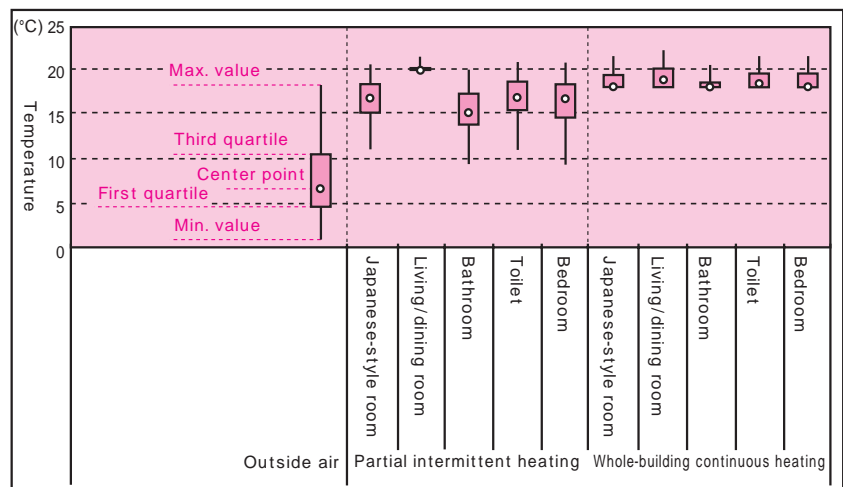
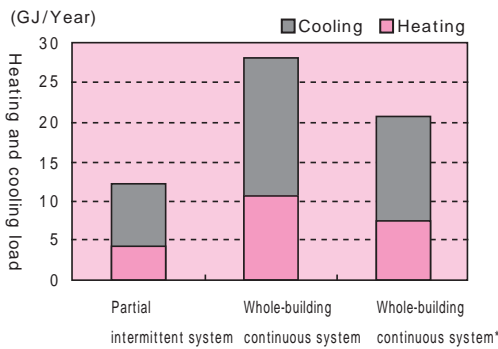

Fig. 1 Energy consumption and indoor temperature differences of partial intermittent operation and whole-building continuous operation

* Shows results when a model with room-by-room temperature control function is used.

Note: The heating and cooling load and room temperature have been calculated with insulation level as equivalent to the 1999 energy conservation standard (Level 3).

- In particular, as the bathroom, washing room and changing room is likely to be poorly insulated, it is necessary to ensure that insulation is properly installed while paying attention to the assembly process of prefabricated bath unit.

Table 10 Temperature differences of heated and unheated rooms by insulation level(Unit:°C)

Insulation level	Heated room	Unheated room			Temperature difference (average)
	Living/dining rooms	Bathroom	First floor toilet	Bedroom	
Level 0	20.0	11.7	12.9	12.1	7.8
Level 1	20.0	13.6	14.8	14.3	5.8
Level 2	20.0	14.9	16.3	15.9	4.3
Level 3	20.1	15.5	16.8	16.3	3.9
Level 4	20.3	15.9	17.5	17.1	3.5

* Insulation level in the above table is from Table 1 of Section 4.1 Insulated Building Envelope Planning for Zone V on p.128.

Conditions

- Heating operation type: Partial intermittent heating
- Comparison time/room: Average temperature at 22:00
- Comparison period: January and February

- Operation methods of heating systems can be categorized into four types depending on the combination. Their general advantages and disadvantages are summarized in Table 11 below.

Table 11 Advantages and disadvantages of heating systems by operation method

Classification by place	Classification by duration	
	Continuous system	Intermittent system
Whole-building system	<Whole-building continuous heating> <ul style="list-style-type: none"> • Energy consumption is high. • Wall surface temperature is close to air temperature so good indoor environment can be maintained. 	<Whole-building intermittent heating> <ul style="list-style-type: none"> • Rooms are cold when occupants wake up or come home in the evening.
Partial system	<Partial continuous heating> <ul style="list-style-type: none"> • Wall surface temperature is close to air temperature so good indoor environment can be maintained. • There are temperature differences between heated and unheated rooms. 	<Partial intermittent heating> <ul style="list-style-type: none"> • Energy consumption is low. • Rooms are cold when occupants wake up or come home in the evening. • There are temperature differences between heated and unheated rooms.

Key Point

Differences in indoor environment between continuous heating and intermittent heating

- The figure below compares the air temperature and wall surface temperature of the living room, dining room and kitchen at 6:00 on a weekday. The temperature is set at 20°C for partial intermittent heating and 18°C for whole-building continuous heating, with partial intermittent heating being 2°C higher.
- Even though the room air temperature is 2°C higher with partial intermittent heating than whole-building continuous heating, the wall surface temperature is lower.
- MRT stands for Mean Radiant Temperature, which is an average surface temperature with the size of wall area considered, and is 1°C higher for whole-building continuous heating than partial intermittent heating. This is because walls and floors cool down during the night and are not warmed enough immediately after the heater is turned on when using the partial intermittent heating system. On the other hand, the whole-building continuous heating system also heats the house during the night and walls and floors are sufficiently warmed.
- The heat transfer of human body is influenced by heat radiation from walls in addition to the surrounding air. Therefore, the room air temperature as well as wall surface temperature affects people's comfort. Operative temperature (OT) is a mean value of air temperature and wall surface temperature, which is one of the indicators of comfort. Although the temperature is set 2°C lower for whole-building continuous heating than partial intermittent heating, both heating systems provide the same level of comfort, as far as assessing in terms of OT.

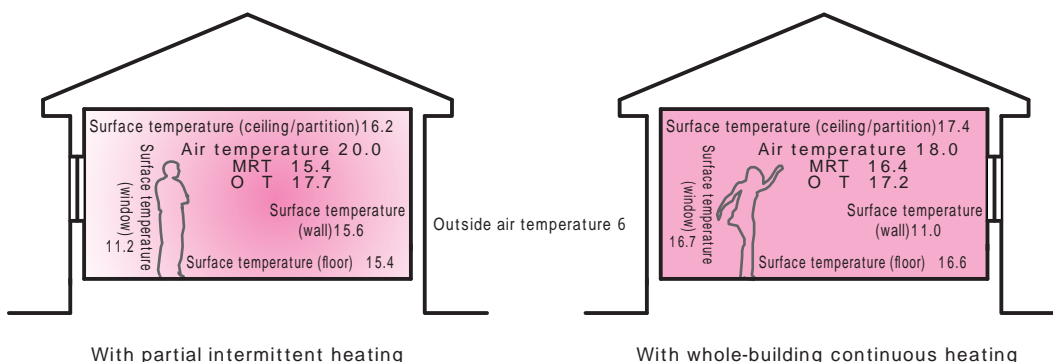

Fig. Air temperature and wall surface temperature in living room, dining room and kitchen

5

Chapter 5 Energy-efficient
Equipment Technology
(Elemental Technology
Application Method 3)

4. Considering types of heating and cooling system (Step 3)

1) Characteristics of each system

Heating and cooling air conditioner, gas hot water heating and forced flue (FF) heating (common characteristics of Types 1 to 3)

- A partial intermittent heating and cooling system that uses an individual heating and cooling device to heat and cool the living, dining and bedrooms separately. The advantage of this system is that the heating and cooling device is installed and operated as needed, but consideration should be made so that the temperature difference with hallways, stairs, washing rooms and toilets, and other unheated or uncooled spaces should not be significant.

Heating and cooling air conditioner (Type 1)

- This efficient device produces heat using heat pump technology. One of the characteristics peculiar to heat pump is that its efficiency varies depending on the load factor, and it is important to select an appropriate device capacity.
- Since it circulates the indoor air for heating and cooling, occupants are likely to feel the airflow, which can cause a chill, particularly during heating. It is necessary to increase the insulation performance and due consideration must be given to the installation position and air outlet direction.

Gas hot water heating (Type 2)

- This system circulates hot water warmed by gas heat source equipment and heats the room using a radiator, fan convector and floor heating.
- A fan convector is a heating system (convection heating) that warms the room with warm air in the same way as a heat pump air conditioner. Therefore, similar to a heat pump air conditioner, it requires due consideration of the installation position and air outlet position.
- A radiator and floor heating is a heating system (radiant heating) that warms the room mainly using radiant heat. Since radiant heating does not stir the room air, not only occupants do not feel the airflow but also the temperature distribution in the room is small, achieving a high level of comfort.
- A radiator and floor heating is controlled so that the surface temperature does not reach too high in order to prevent the risk of burns. Because of this, if the panel area is small it may result in lack of heat radiation, thus a sufficient panel area needs to be designed.

FF heating (Type 3)

- This type of device has the highest heating capacity compared to other types used for partial intermittent system, thus the time to reach the set temperature after the operation is started is the shortest.
- Similar to a heat pump air conditioner, it is a convection heating system and tends to have a significant vertical temperature gradient. Additionally, as it causes airflow due consideration must be given to the installation position and air outlet direction.

Duct central heating and cooling (Type 4)

- This whole-building continuous heating and cooling system carries cool or warm air to each room through a duct using a heat pump heat source installed for the entire house or on each floor. Combined with a ventilation system, it heats, cools and ventilates the entire house.
- Unlike the partial heating and cooling, it heats and cools the entire building and maintains an almost uniform thermal environment throughout the house. This enables a high level of comfort without temperature differences between the heated rooms and hallways and other unheated areas, but the energy consumption increases.
- This is a convection heating and cooling system, similar to a heating and cooling air conditioner. Therefore, it requires due consideration for the installation position and air outlet direction.

2) Balance of comfort and cost

- Considering economic efficiency, both initial and running costs are generally lowest when using a partial intermittent system such as a heat pump air conditioner and FF heating system.
- The whole-building continuous system provides greater comfort while the partial intermittent system achieves higher energy efficiency.

- Since incentive programs may be available for energy-efficient heating and cooling systems, architects need to fully understand these programs from the homeowners' perspective.

3) Adopting system that is suitable for characteristics of indoor space

- Since the vertical temperature gradient in the room with a high ceiling or vaulted ceiling tends to become significant, floor heating is appropriate for keeping feet warm. It is also a good idea to stir the indoor air using ceiling fans or other devices in order to decrease the vertical temperature gradient.
- For a house comprised of large space with few partitions (open space layout), a duct central heating and cooling system which warms the entire house is suitable.

Key Point

Indoor temperature distribution differences between heat pump air conditioners and floor heating

- Heat pump air conditioners and other convection heating systems send warm air, and the warm air rises to the ceiling while the cold air descends from the windows or enters from the unheated space flows around the floor, which tends to cause a significant vertical temperature gradient in the room. On the other hand, as floor heating warms the indoor air in addition to receiving radiant heat from the floor, it maintains low air temperature to create a comfortable indoor environment with a low vertical temperature gradient.
- Fig. a shows vertical temperature distributions when the heating systems are used. Since occupants often sit on the floor or chair, the temperature at 0 to 1,200 mm from the floor is important. When a heat pump air conditioner is used, particularly if the insulation performance of the house is low, the temperature decreases as it nears the floor. To solve this problem, some special considerations are required such as increasing the insulation performance, preventing drafts by extending curtains to the floor and lowering air outlet direction. Meanwhile, floor heating hardly produces a vertical temperature distribution and creates a warm space including the floor surface.
- Fig. b shows horizontal temperature distributions when the heating systems are used. You can see the temperature is higher near the air outlet of air conditioner. It may be necessary to adjust the wind direction of air outlet so that the heated air does not directly hit the occupants.

Glossary: Draft
Discomfort caused by the cold local airflow in the room. It is also referred to as "cold draft".

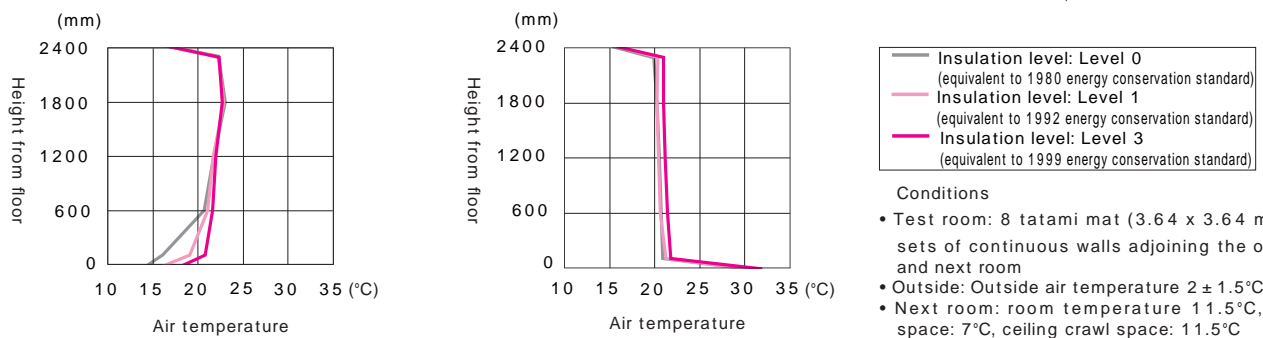

Fig. a Vertical temperature distributions during heating (room center) (Left: heat pump air conditioner; right: floor heating)

— Insulation level: Level 0 (equivalent to 1980 energy conservation standard)
 — Insulation level: Level 1 (equivalent to 1992 energy conservation standard)
 — Insulation level: Level 3 (equivalent to 1999 energy conservation standard)

Conditions

- Test room: 8 tatami mat (3.64 x 3.64 m), two sets of continuous walls adjoining the outside and next room
- Outside: Outside air temperature $2 \pm 1.5^\circ\text{C}$
- Next room: room temperature 11.5°C , crawl space: 7°C , ceiling crawl space: 11.5°C
- Air conditioner: rated heating capacity 3.2 kW, 30° , set temperature 22°C
- Floor heating: rate of floor heating area 83% (floor heating area 11 m^2), set temperature 22°C (remote controller position: near indoor wall, at 1,200 mm high)

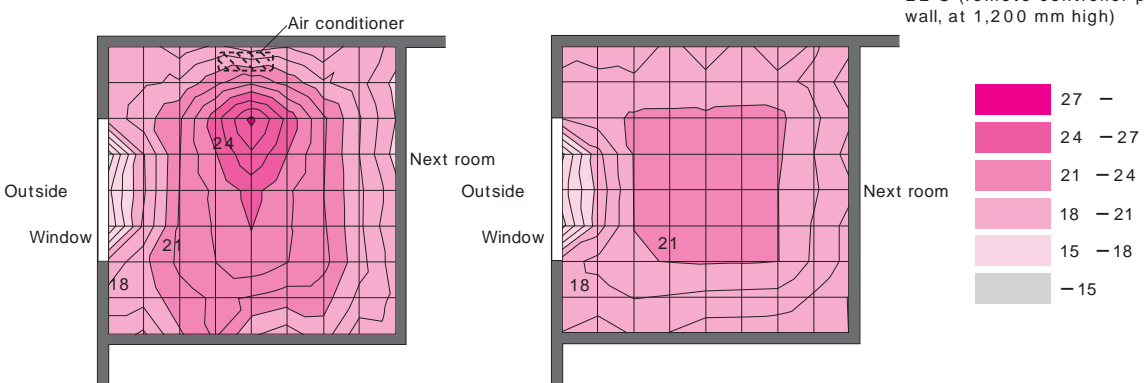

Fig. b Horizontal temperature distributions during heating (height: 1,200 mm) (Left: heat pump AC, right: floor heating)

5

5.2.4 Energy Saving Methods in Heating and Cooling System Planning

Type 1 Heating and cooling air conditioners

- Generally, a heating and cooling air conditioner is installed individually in every room in the house including the living, dining and bedrooms and is operated as needed, as a partial intermittent heating and cooling system.

1. Energy saving methods (Type 1)

Method 1: Adopting high-efficiency air conditioners

- Energy conservation target levels for heating and cooling air conditioners can be achieved by adopting a heating and cooling device with high energy consumption efficiency (COP).
- COP is an indicator of operation efficiency of air conditioners. COP is a value indicating the heating and cooling capacity divided by power consumption and is known to fluctuate depending on various operating conditions.

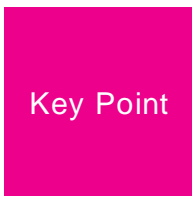

Air conditioner efficiency

- Fig. a shows the relationship between the outside air temperature, load factor (ratio of heating and cooling capacity to rated capacity), and COP. For example, the higher the outside air temperature, the greater the COP during heating. Moreover, COP becomes the highest at the capacity, near approximately half of the maximum load factor (maximum capacity). The greater the heating and cooling load belonging to this range, the higher the annual operation efficiency.
- The air conditioner capacity increases the lower the outside air temperature when cooling, and the higher the air temperature when heating. For example, when the outside air temperature of 7°C is set as the standard temperature for heating, the capacity increases approximately 10% at 12°C whereas it decreases approximately 10% at 2°C.

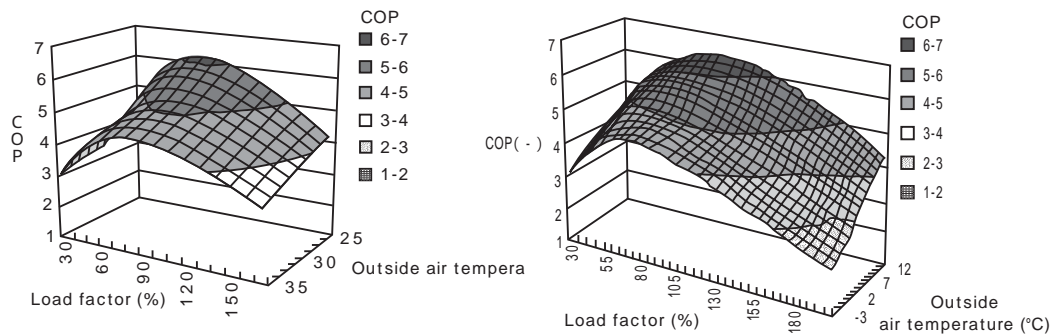

Fig. a Relationship between outside air temperature, load factor and COP (left: cooling, right: heating)

- As the indoor relative humidity changes during cooling, so is the air conditioner capacity and COP. Fig. b shows the result of comparing the indoor humidity (dry bulb: 27°C, wet bulb: 19°C, relative humidity: approximately 47%), which is specified as the COP measuring condition by the Japanese Industrial Standards (JIS), with COP under high humidity conditions. For example, when the relative humidity is 55 – 60%, the device capacity and COP increase 10 – 15%.

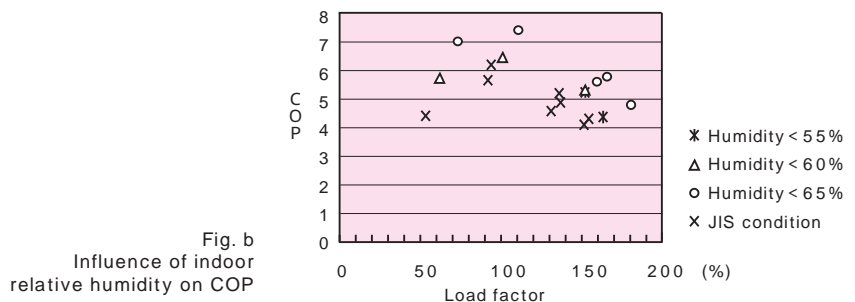
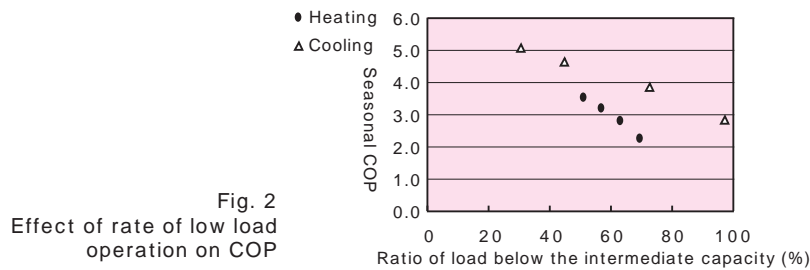

Fig. b Influence of indoor relative humidity on COP

Method 2: Setting appropriate device capacity

- Generally, the operation load of air conditioners is high immediately after heating or cooling has started although it is low other times and COP declines as shown in the figure of Key Point on p.230. The indoor heating load becomes extremely low particularly when an air conditioner is operated for extended periods of time, and the air conditioner may go into intermittent operation. Since COP further decreases during intermittent operation, it is not desirable to continuously operate an air conditioner under a low load and intermittent state from an energy saving perspective.
- If the air conditioner you selected has an excessive capacity compared to the heating and cooling load of the room, the time for reaching a certain room temperature is shortened and the level of comfort increases. However this also increases the ratio of inefficient, low load operation.
- Since the maximum air conditioner capacity is higher than the rated capacity indicated as a typical device capacity in the catalogue, it is necessary to select a model with appropriate maximum capacity compared to the maximum heating load of the room. The appropriate maximum capacity varies depending on the room temperature rise time as mentioned above, i.e. the time that has been set to reach a comfortable room temperature after the air conditioner starts operation. Fig. 2 shows the result of investigating the effect of the ratio of operating an air conditioner at or below the intermediate capacity (half of the rated capacity), i.e. low load operation, on COP for both heating and cooling periods. Even when using the same model, seasonal COP increases as the ratio of low load operation decreases.



- It is important to set an appropriate capacity when installing an air conditioner. When the air conditioner is also used for heating, heating load is generally higher than cooling load, thus selection of a heating capacity suitable for the heating load is required. If the air conditioner capacity is insufficient, you will encounter such problems as the room never being heated or not being quickly heated. On the other hand, if the capacity is excessive, the room can be sufficiently heated or cooled but the air conditioner is operated intermittently during the season with low heating and cooling load, which is inefficient and results in increased energy consumption. Larger air conditioner capacity does not mean better; rather it is important to select an air conditioner that has the appropriate capacity by taking into account the size and usage of the room.
- Select a heating and cooling device that provides the appropriate output and as high COP as possible according to the target level. Table 12 shows, for reference purposes, the heating and cooling capacity of devices deemed appropriate for the room size based on the target level for insulated building envelope planning (see Section 4.1.2 on p.128).
- What is important here is to select a 'device that provides the appropriate output according to the load of the room', not a 'device that provides the output exceeding the load of the room'. Regardless of whether it is a heating and cooling device, the use of any device which produces more than the required output will reduce the energy consumption efficiency.

Table 12 Capacity as guideline for selecting heater (required maximum heating capacity) (Unit: kW)

Insulation level		6 tatami mats (10 m ²)	8 tatami mats (13 m ²)	10 tatami mats (16 m ²)	14 tatami mats (22 m ²)	
Level 0	1980 energy conservation standard	2.7	3.6	4.5	6.3	
Level 1	1992 energy conservation standard	(Medium airtight)	2.2	2.9	3.6	5.0
		(Airtight)	2.3	3.0	3.7	5.2
Level 2	Intermediate of 1992 and 1999 energy conservation standards	Reinforced ceiling and opening insulation	1.8	2.4	3.0	4.2
		Mud-plastered wall	1.8	2.4	2.9	4.1
Level 3	1999 energy conservation standard	Evenly distributed insulation	1.8	2.4	3.0	4.2
		Reinforced ceiling and opening insulation	1.8	2.3	2.9	4.1
		Reinforced opening insulation	1.7	2.2	2.7	3.8
		Mud-plastered wall	1.8	2.3	2.9	4.0

Note: The shaded figures indicate that a model with a device capacity (rated cooling capacity) of 2.2 kW meets the maximum heating capacity indicated in the table. Please select a model with a device capacity (rated cooling capacity) of 2.8 kW for other figures.

5

Key Point

The importance of selecting air conditioners appropriate for load

- Fig. a Comparison of efficiency between conventional and energy-efficient air conditioners shows the relationship between the outside air temperature and the energy efficiency of a conventional air conditioner (rated COP≈2.7) and an energy-efficient air conditioner (rated COP≈5.8) measured using actual units placed in a living room. This figure confirms the energy saving effect of an energy-efficient device.
- Fig. b Comparison of efficiency between living room and children’s room shows the efficiency of devices with identical COP when one is placed in a living room while the other in a children’s room. Although the COPs of both devices are almost identical, it is apparent that the efficiency of the air conditioner placed in the children’s room is lower. It can be presumed that this is caused by the children’s room being small, thereby requiring small heating load.
- Fig. c Frequency distribution of load factor shows the amount of output when in operation compared to the device’s maximum output. It is shown that, during summer months, the air conditioner in the living room operated at approximately 40% of the maximum output while the one in the children’s room was operating merely at 10%. In other words, when the capacity of the device far exceeds the load of the room, it can lead to inefficient operation that does not take full advantage of the fact the device itself is efficient. The adequate capacity of the device to be selected therefore needs to be determined with the help of Table 12 (p.231) and other tools.

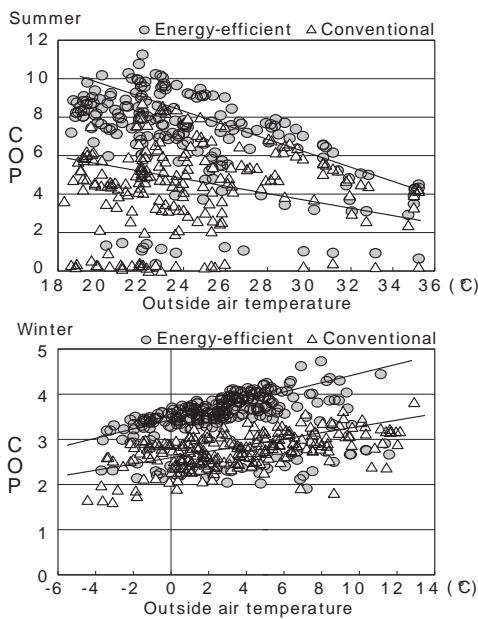

Fig. a Comparison of efficiency between conventional and energy-efficient air conditioners

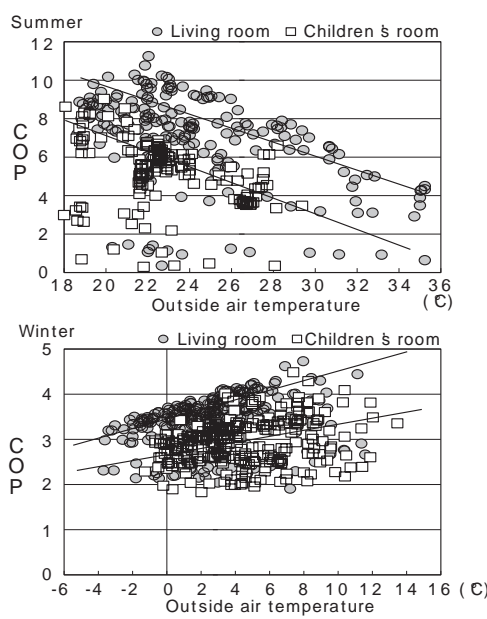

Fig. b Comparison of efficiency between living room and children’s room

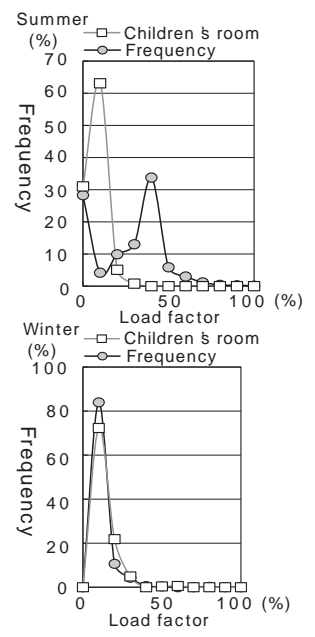

Fig. c Frequency distribution of load factor

Comment Air conditioner’s dehumidification function

We are recently seeing many air conditioners with a dehumidification function that employs a method called reheat dehumidification. The traditional dehumidification method had a shortcoming whereby it excessively decreased the room temperature. The reheat dehumidification method, on the other hand, dehumidifies the air by cooling it then reheats it before

releasing it back into the room, which alleviates the discomfort of the dehumidification process. However, it should be noted that the reheat dehumidification operation requires more energy than the conventional dehumidification operation as well as a regular cooling operation.

Method 3: Using electric and ceiling fans (cooling only)

- Using electric and ceiling fans allows us to set a higher cooling temperature for the air conditioner. Fans also contribute to minimizing the hours required for cooling. It can be expected that setting a higher cooling temperature will result in less consumption of cooling energy.

1) Using electric fans

- Electric fans can be useful in limiting the use of cooling as they lower thermal sensation due to a breeze. Occupants can turn on a fan temporarily at a higher setting (high or medium) after returning from work or taking a bath.
- It is still difficult to quantitatively evaluate the cooling sensation created by the airflow of an electric fan. However, even though cooling systems have become commonplace, the energy saving effect of frequently used electric fans cannot be overlooked. The amount of heat removed from the body surface by the airflow varies depending on factors such as the speed of the airflow, the cycle (oscillation cycle, etc.) and the evaporation of sweat.
- Table 13 shows the measured results of the power consumption and the wind speed using two models of electric fans. Model 2 is shown to consume less power yet provides a higher wind speed, which means it is more efficient.

Table 13 Measured results of power consumption and wind speed of electric fans

Rated power consumption (W; 50/60 Hz)		Model 1			Model 2		
		52/53			40/43		
Wind speed setting		Low	Medium	High	Low	Medium	High
Power consumption (W; 50 Hz)	W/ oscillation	40	46	56	24	31	50
	W/O oscillation	37	44	54	23	31	49
Wind speed W/O oscillation (Average value at the top speed; m/s)	At 2 m	1	1.1	1.2	1.2	1.4	2
	At 3 m	0.6	0.7	0.8	1	1.2	1.4
Full oscillation cycle (s)		21.8	18.9	16.4	25.7	20.0	15.3

- From our estimates, it was shown that 1°C in reduction of thermal sensation can be expected when the electric fan is placed at a distance of 2 to 3 m (when used for a long period of time at a low wind speed setting with oscillation). As we can expect to lower the thermal sensation by 1°C and can set the cooling temperature of the air conditioner 1°C higher, using an electric fan along with an air conditioner can be said to have a cooling energy saving effect. On the other hand, if the cooling temperature of the air conditioner remains unchanged when used in conjunction with an electric fan, the energy consumption simply increases for the amount used by the electric fan.

2) Using ceiling fans

- Ceiling fans (Fig. 3) can send airflow to a wider area than electric fans and can have a more general effect in reducing thermal sensation. If the ceiling offers a good height such as a vaulted ceiling where warm air tends to pool, a ceiling fan can limit the increase of the temperature on the ceiling surface by circulating the air as well as reduce the thermal sensation within the area. (However, if the cause of the warm air pooling at the ceiling is weak insulation or solar shading in the roof or attic, using a ceiling fan may increase the cooling energy consumption.)
- Ceiling fans consume approximately the same amount of energy as electric fans but cover a wider area with airflow, which means that they can have a more general effect in the room to reduce the thermal sensation. (When an experiment was conducted with a ceiling fan with a ceiling height of 4.9 m, the wind speed obtained was 0.3 m/s at medium setting and 0.1 to 0.2 m/s at low setting within the area. The wind created at medium setting appears to be sufficient to be felt by occupants.)
- Although ceiling fans can be difficult to install unless the ceiling height is relatively high, more and more products now combine the fan and the lighting to facilitate installation. In terms of safety and other factors, a ceiling height of 2.5 m seems to be the minimum requirement. (The distance between the ceiling surface and the lowest point of the fan can be as small as 20 cm or so depending on the product.)
- We are increasingly seeing fans with simple, modern designs in addition to the conventional classic design, which gives consumers a wide range of selection design-wise.



Fig. 3 Example of ceiling fan

5

Chapter 5 Energy-efficient Equipment Technology (Elemental Technology Application Method 3)

2. Considerations for energy efficiency planning and design (Type 1)

- It is important to install an air conditioner with good energy consumption efficiency (COP) for cooling the house in summer. It is also vital to reduce the cooling load by utilizing wind as well as ceiling fans (See Section 3.1 Use and control of wind).
- When building a house, it is desirable to install sleeves which accommodate air conditioner piping during the construction stage as much as possible. Since carelessly drilling a hole in the wall after the house is completed can impair the insulation performance or air tightness, it should be discussed with the home-builder prior to the construction. Fig. 4 is an example of insulation being drilled with a hole saw after the house was built.
- If the space around the outdoor unit is insufficient, the heat exchanged air stagnates, causing a reduced heating and cooling capacity and decreased COP. Therefore, it is desirable to install an outdoor unit in as large an area as possible. However, if this results in increased distance from the indoor unit, again the COP deteriorates.



Fig. 4
Example of insulation being drilled with hole saw

3. Considerations for operation systems (Type 1)

- When heating the living room at the time the occupants wake up in winter, it takes time for the room to reach the set temperature, regardless of type of heater. Because of this, an electric carpet, electric heater or kotatsu (a small quilt-covered table with an electric heater affixed underneath) is also used as soon as the heat pump air conditioner is turned on. Nevertheless, the heat pump technology of air conditioner efficiently generates heat, providing a few times higher heat generation efficiency than an electric carpet, electric heater or kotatsu. Even if the air conditioner is turned on with a timer to heat the room 30 minutes to an hour before the occupant uses the room, energy consumption increase is not very significant.
- The COP of the device tends to increase as the set temperature increases for cooling and decreases for heating. Since setting the room temperature higher during cooling and lower during heating not only decreases the heating and cooling load but also increases COP, energy saving effects can be expected. However, if the device installed has an excessive capacity, the ratio of low load operation increases and COP may deteriorate.
- There is often a difference between the set temperature of the remote control and the actual temperature of the living area. This is mainly because the air conditioner is often controlled based on the temperature around the air inlet of the indoor unit and there is a temperature difference between the living area and the air inlet temperature due to the indoor vertical temperature gradient, in addition to the control characteristics of the device. Regarding a comfortable indoor condition and how to set the remote control for it, occupants need to ingeniously operate the air conditioner for example, placing a desktop thermometer in the room for checking the appropriate temperature.
- Air conditioners can cause a chill particularly when the airflow directly hits the body during heating. Careful consideration is required regarding the installation position and air outlet direction of the indoor unit.

Comment APF indication

Annual performance factor (APF) will replace COP as an index that indicates the efficiency of air conditioners. While COP represents the air conditioner efficiency under a certain load (rated condition), APF indicates an annual energy efficiency of heating and cooling a building in Tokyo with an air conditioner. Therefore, this index also considers the efficiency for factors other than rated conditions—for example, changes in the efficiency due to the influences of outside air temperature and level of heating and cooling load—and is intended to indicate efficiency that is closer to the reality.

However, the heating load distribution is influenced by factors such as the weather, insulation performance, operation method and operation type, and varies from house to house. Because of this, the actual annual energy efficiency of using an air conditioner and the APF value are not the same. The figure on the right compares the value estimated by APF and the calculated value of an actual house regarding the heating and cooling load distribution in relation to the outside air temperature. Of course, the load distribution of the calculated value also changes according to the building insulation performance. Therefore, APF should also be treated as a guideline for indicating the device performance, just like COP. You can use COP and APF alone especially for relatively comparing the performance of air conditioners. However, to compare the

energy saving effects of different heating systems, how much energy is actually consumed is the key and it is necessary to make any selection by referring to the values shown in this document and other data.

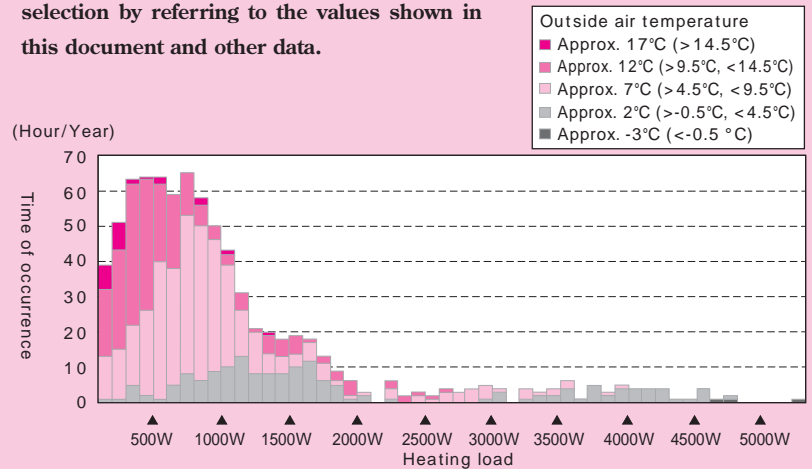

(a) Heating load distribution in living/dining room/kitchen used in this document
* Calculation is based on the insulation level of 1999 energy conservation standard (Level 3).

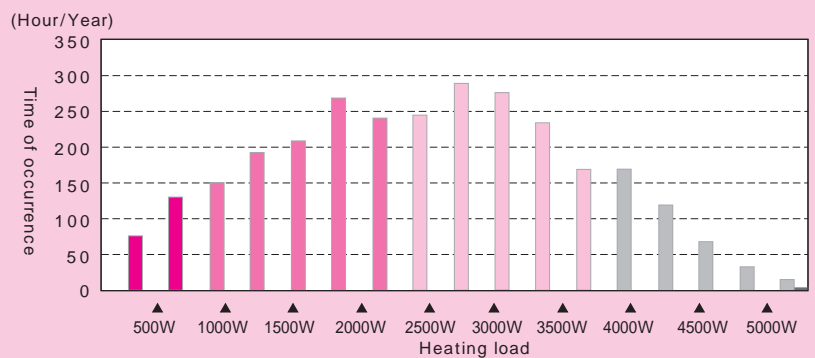

(b) Heating load estimated for APF
* Calculation is based on rated cooling capacity of 5 kW.

Fig. Heating and cooling load distribution in relation to outside air temperature

Type 2 Gas and oil hot water heating

- Generally, in the case of hot water heating, a radiator is installed individually in every room in the house including the living, dining and bedrooms and is operated as needed, as a partial intermittent heating system.
- Floor heating is a heating method that retains a high level of indoor comfort as it effectively reduces discomfort caused by cold draft (see Glossary on p.229) from the windows and easily maintains a uniform indoor thermal environment. A panel radiator also has the similar effect, but the location of panels needs to be deliberately examined, such as below the waist-level window.
- Compared to forced flue (FF) heating, hot water heating tends to have higher initial and running costs. Nevertheless, this heating method maintains a high level of indoor comfort if a radiator or floor heating is used.
- To reduce energy consumption, attention must be paid to the appropriate piping insulation, appropriate floor insulation (only if floor heating is used), and use of high-efficiency heat source equipment. Lowering the supply water temperature generally decreases the radiation heat loss from the heat source equipment and pipes. It is advisable to consider using the heat source equipment with selectable temperature setting and securing the radiator area that sufficiently heats even at low temperatures.

5

1. Energy saving methods

Method 1: Adopting high-efficiency heat source equipment

- The efficiency of heat source equipment is expressed with energy consumption efficiency, which is obtained by dividing the heating output of the heat source equipment with fuel consumption (heat quantity). The higher this value, the lower the fuel consumption the equipment requires to produce hot water of the same temperature and quantity. Please select the heat source equipment with as high energy consumption efficiency as possible.
- In addition to an ordinary gas water heater, a latent heat recovery gas water heater is also a heat source of hot water heating. An oil water heater and heat pump heat source can also be used in addition to a gas water heater, and high-efficiency heat source equipment is anticipated to increase the energy saving effect of floor heating.

Key Point

Efficiency of heat source equipment

- The figure below shows an output efficiency of heat source equipment. It is clear that the smaller the output the lower the efficiency. The heat source equipment efficiency declines significantly in the output range of approximately below 2,000 W that occurs when a heat source equipment burner is turned on or off. Generally, heat source equipment with a large capacity has a high lower limit of continuous combustion output of a burner and is often turned on and off. The use of heat source equipment with an excessively large capacity should be avoided.
- (A) in the figure represents the efficiency of gas heat source equipment when the prompt heating mode is used. This operation mode quickly heats the room immediately after the floor heating is started by supplying hot water at a higher temperature (e.g. 75°C) than normal. Although this operation mode instantly heats the room and provides comfort, the efficiency deteriorates as shown in the figure. If the room is already warm, it is recommended to turn off this mode with a remote control. For example, when operating floor heating after getting up in the morning, if the insulation performance of the house is high, it reduces the coldness of the room (temperature increases) thus the duration for using this operation mode can be shortened.
- (B) in the figure represents the heat source equipment efficiency when the supply water temperature is set low. The lower the hot water temperature, the better the heat source equipment efficiency. Especially when using latent heat recovery heat source equipment, more latent heat is recovered if the hot water temperature is low and it is important to choose a device that can control low temperature water. However, if the supply water temperature is low, the heat radiation from floor heating decreases. It is advisable to reduce the heating load by increasing the insulation performance of the house when using this type of heat source equipment.

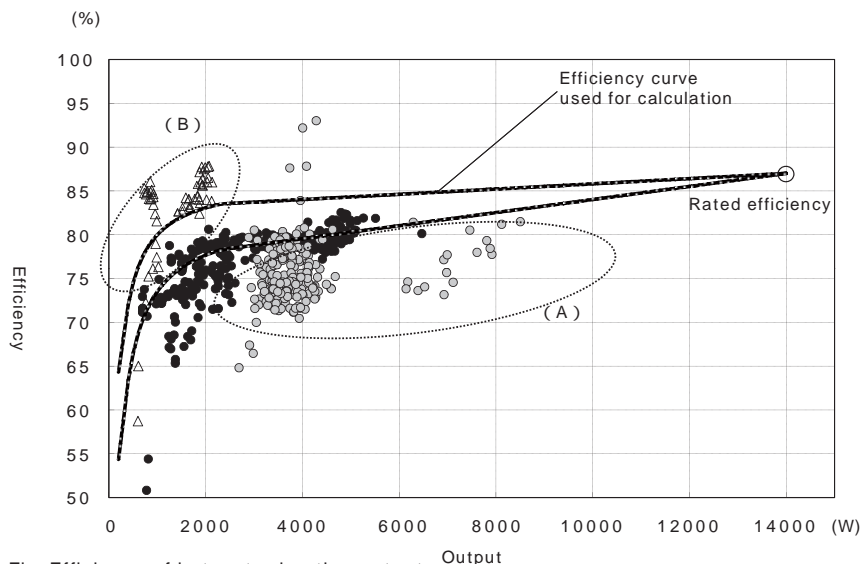

Fig. Efficiency of hot water heating output

Method 2: Lowering supply water temperature of heat source equipment

- If the supply water temperature is lowered, heat loss from piping and other elements decreases while the efficiency of heat source equipment generally increases. On the other hand, when comparing radiators in the same room size, the lowered hot water temperature decreases the heating capacity, which may lead to an insufficient heating capacity during severe winter months. In order to lower the hot water temperature for energy conservation, it is necessary to fully insulate the building to reduce the heating load as well as increasing the area of heat radiation panels (including floor heating panels).

Method 3: Underfloor and piping insulation and shortening piping length

- It is important to use thick insulation underneath the floor and properly install hot water piping insulation in order to prevent heat loss in the crawl space and other unheated spaces.
- A considerable amount of heat is estimated to be lost from the circulation pipes between the heat source equipment and the floor panels. Therefore, it is necessary to sufficiently perform thermal insulation of piping and shorten piping length. For thermal insulation, bare tubes covered with 10-mm thick expanded polyethylene should be used for piping or insulation should be installed around the piping so that it ensures the same level of insulation performance (linear thermal transmittance of not more than 0.15W/m·K).
- Underneath the floor heating also requires a sufficient level of insulation. Insulation materials with a thermal resistance of at least 1.6 m²K/W (60-mm thick 32K glass wool board or 75-mm thick 16K glass wool board) should be used.

Method 4: Adopting floor heating and increasing rate of floor heating area

- Any floor heating system that is designed to heat the entire room (e.g. one providing at least 70% of floor heating area against the total heating area) can lower the room temperature while maintaining the same level of comfort as other heating systems. However, this does not apply to any floor heating system with a small heating area, such as that intended for heating occupants' feet in the kitchen.

Key Point

Designing appropriate panel radiating area

- The amount of heat radiation from convectors, radiators and floor heating is determined by the radiating area and temperature of supplied hot water. It is important to design the radiating area so that a sufficient heating capacity is ensured during the coldest days of the year when the heating load is high. Since the temperature of supplied hot water is limited, it is necessary to secure a sufficient radiating area. When calculating a radiating area, the supply water temperature is set at a certain level, 60°C for example. If the installation space is permitted, it is recommended to use a large radiator. This is because a large radiator radiates more heat at the same supply water temperature than a small radiator and can easily maintain room temperature even during the coldest days of the year when the heating load is high. Moreover, when comparing these radiators in terms of the same amount of radiation, a large radiator can reduce the supply water temperature or shorten the time in which water is supplied, and thus decreased heat loss from piping and increased efficiency of heat source equipment are expected. However, this will decrease heat radiation from floor heating. It is advisable to reduce the heating load by increasing the insulation performance of the house when using a large radiator.

5

Chapter 5 Energy-efficient Equipment Technology (Elemental Technology Application Method 3)

Key Point

Heat loss by heat source equipment and underfloor and piping insulation

- We will present four examples of energy consumption of hot water floor heating by means of different heat source equipment, with or without piping insulation, and with different thicknesses of insulation under the floor heating panels.
- Fig. a is a case in which energy saving methods were not applied.
- Fig. b shows a case of increased heating area and shortened piping length in addition to Method 3 which adopts both piping insulation and underfloor insulation. Compared with Fig. a, energy consumption decreases by approximately 9%.
- Fig. c is the same as Fig. b except for adopting high-efficiency heat source equipment (Method 1).
- Fig. d is the same as Fig. c except selecting a latent heat recovery device that can reduce the supply water temperature (40°C) and adopting Method 2. Lowering the supplied hot water temperature increases the heat source equipment efficiency and further decreases energy consumption by approximately 11%.

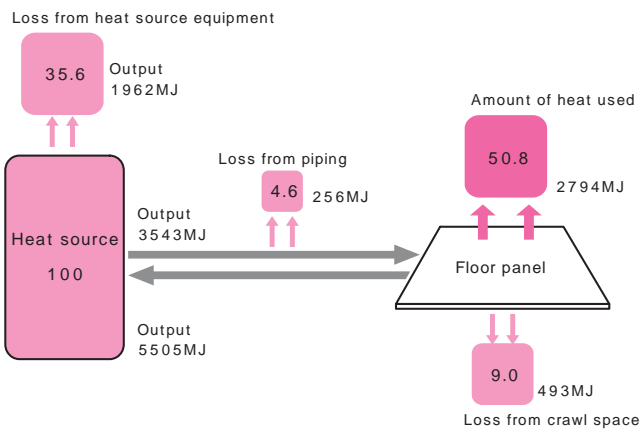

Fig. a Conventional heat source equipment + poor underfloor insulation, without piping insulation (Case 1)

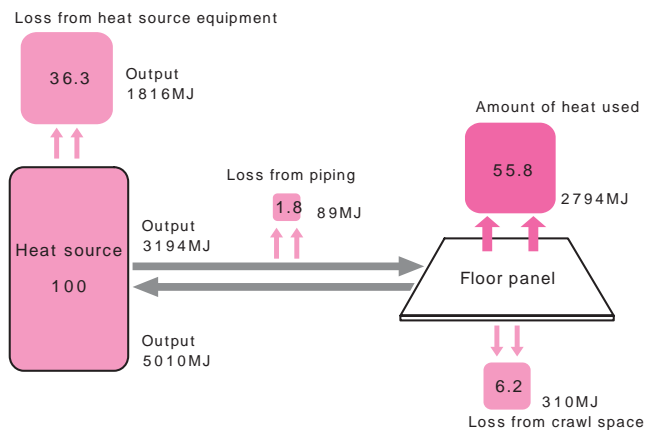

Fig. b Conventional heat source equipment + high underfloor insulation, with piping insulation (Case 2)

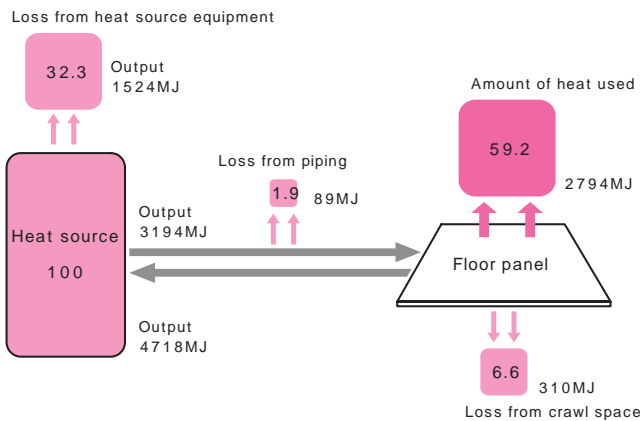

Fig. c High-efficiency heat source equipment + high underfloor insulation, with piping insulation (Case 3)

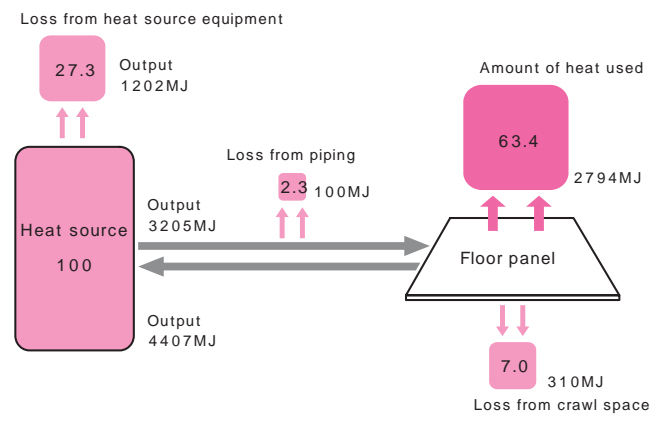

Fig. d High-efficiency heat source equipment (low supply water temperature) + high underfloor insulation, with piping insulation (Case 4)

Calculation conditions

- Floor heating location: first floor living/dining room (floor area: 21.5 m²) and kitchen (floor area: 8.3 m²) of detached house
- Rate of floor heating area: (1) standard 70% (floor heating area: 20.9 m²), (2) high 75% (floor heating area: 22.4 m²)
- Piping length: (1) standard 29.6 m, (2) short 15.5 m
- Heat source equipment (rated efficiency): (1) conventional 78.0%, (2) high-efficiency 83.0%, (3) latent heat recovery 86.0%
- Underfloor insulation: (1) low level (thermal resistance: 1.0 m²K/W, 50-mm thick 16 K glass wool), (2) high level (thermal resistance: 1.6 m²K/W, 60-mm thick 32 K glass wool)
- * (1) uses standard rate of floor heating area and (2) uses high rate of floor heating area.
- Piping insulation: (1) without piping insulation (heat loss coefficient: 0.21 W/mK), (2) with piping insulation (heat loss coefficient: 0.15 W/mK)
- * (1) uses standard piping length and (2) uses half piping length.
- Supply water temperature: 60°C (standard), 40°C (in case of low supply water temperature)

3. Considerations for energy efficiency planning and design (Type 2)

- As mentioned in Method 2, increasing the temperature of supplied hot water will increase the heat source equipment efficiency. This also decreases the heat loss from piping. Therefore, decreasing the temperature of hot water to be supplied as much as possible is effective for saving energy. However, lowering the hot water temperature decreases the amount of heat radiation, which is likely to result in a lack of heating capacity. It is necessary to increase the insulation level to reduce the heating load and secure a large panel radiating area so that the supply water temperature can be reduced.
- It is effective to shorten the piping length on top of insulating the piping in order to reduce the heat loss from the hot water piping. Another good idea is to install heat source equipment near the room that is most frequently heated (e.g. living room).
- If the same heat source is shared between the domestic hot water system and the heating system, it is important to pay attention to the piping plan and install a device that minimizes the piping length. On the other hand, if another heat source equipment is used for the heating system, installing it on the balcony in front of the living room, in which the heating system is used most frequently, can shorten the piping length.

3. Considerations for operation systems (Type 2)

- As it takes time to heat the floor when using a floor heating system, it is effective to set the timer so that the system starts running 30 minutes before the occupants use the room, such as when they wake up in the morning or come home in the evening. Meanwhile once the floor is heated it stays warm even if the system is stopped, it is effective to stop the system earlier before going to bed or going out.

Comment Heat pump hot water floor heating and electric floor heating

Recently, it is becoming popular to use the same heat pump technology used for air conditioners in the heat source equipment for hot water heating. Similar to air conditioners, this heat source equipment is energy efficient because it generates three to four times more heat than the consumed power.

On the other hand, heat source equipment that uses an electric heater is also becoming prevalent. This heat source directly converts the power consumed by an electric heater into heat energy and can only generate the same

amount of heat as the consumed power. In the case of electric floor heating, it is possible to reduce the running cost using late-night power, but this is not energy efficient when evaluating the primary energy consumption from an energy saving perspective. If an electric floor heating system is installed, it is recommended to replace the heat source equipment with gas or other type of energy when renewing the heat source equipment, or switch to heat pump heat source equipment that is more efficient than an electric heater.

5

Chapter 5 Energy-efficient
Equipment Technology
(Elemental Technology
Application Method 3)

Type 3 Forced flue (FF) heating

- Generally, FF heating is installed individually in every room in the house including the living, dining and bedrooms and is operated as needed, as a partial intermittent heating system.

1. Energy saving methods (Type 3)

- Although this document does not suggest any specific energy saving method for this heating system (See p.222), when choosing FF heating, select the device that has as high a combustion efficiency as possible.
- In addition, as FF heating heats the furnace first when it is ignited, selecting a device that consumes less power during ignition is also critical.

2. Considerations for energy efficiency planning and design (Type 3)

- If the device selected has an excessive capacity compared to the heating load, it goes on and off repeatedly. Generally, the combustion efficiency is low during ignition or consumes a lot of power as it heats the combustion area. Because of this, it is important to prevent the device from going on and off repeatedly (i.e. intermittent operation) as much as possible. It is also vital to select a device with appropriate capacity according to the heating load (see Table 12 on p.231) by taking into account the location and insulation performance of the house.
- It is effective to install the device near the windows in order to achieve a uniform temperature distribution in the room and prevent cold drafts particularly from windows. Since this requires a flue duct to be installed, the device should be placed near the outside-facing wall.
- Please avoid placing the flue duct of the heater where the air becomes stagnant as it might cause the duct to reabsorb the combustion gas, which results in imperfect combustion.

3. Considerations for operation systems (Type 3)

- Lowering the set temperature of FF heating will provide energy saving effects in the same way as other heaters.
- Similar to heat pump air conditioners and hot water heating, this is a convection heating system which circulates the indoor air. Occupants are likely to feel the airflow, which can cause a chill, particularly during heating.

Type 4 Duct central heating and cooling

- Central heating and cooling is a whole-building continuous heating and cooling system which carries cool or warm air to each room through a duct using a heat pump heat source installed for the entire house or on each floor. Combined with a ventilation system, it heats, cools and ventilates the entire house (Fig. 5).
- As this system achieves a uniform thermal environment throughout the house and barrier-free design features regarding the thermal environment, it dramatically enhances the comfort but energy consumption tends to increase compared to the partial intermittent heating and cooling system.
- When using the central heating and cooling system, it is desirable to apply at least Level 3 for insulated building envelope planning (see Section 4.1.2 on p.128) and at least Level 2 for solar shading methods (see Section 4.3.2 on p.190). The greater the insulation level, the higher the energy saving effects.

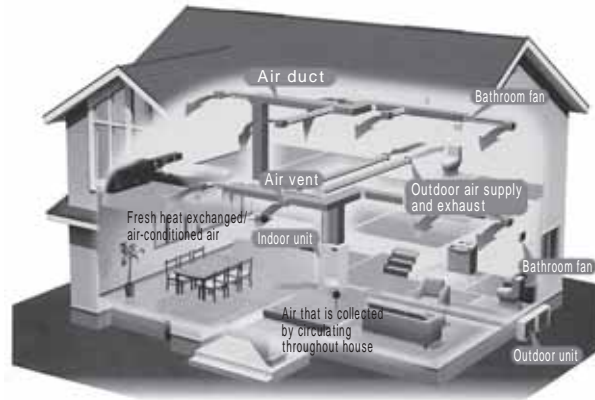

Fig. 5 Example of central heating and cooling

1. Energy saving methods (Type 4)

Method 1: Adopting high-efficiency equipment

- Since this system uses a heat pump in the same way as a heating and cooling air conditioner, the first thing of importance is to adopt a heating and cooling device which has high energy consumption efficiency (COP) in order to increase energy efficiency. A rated cooling efficiency of at least 4.0 is required.

Method 2: Adopting model with room-by-room temperature control function

- When the device has a room-by-room temperature control function, you can reduce the heating and cooling load by setting the heating and cooling temperatures of a guest room or other rooms which are not usually used closer to the outside air temperature than other habitable rooms (used for extended periods of time).

2. Considerations for energy efficiency planning and design (Type 4)

- An intermittent heating and cooling system receives a high load immediately after it is turned on, while this does not occur to a continuous heating and cooling system. That is why you can use a continuous system that has a relatively smaller capacity in terms of the total processing ability than that of an intermittent heating and cooling device.
- Although a duct should always be insulated in order to supply the required heat, the insulation should be more thoroughly installed, particularly when the duct is placed outside the insulated areas. The duct should be insulated at least at the same level as the insulated areas.

5

Chapter 5 Energy-efficient Equipment Technology (Elemental Technology Application Method 3)

- Since the air is constantly sent from the fan, it is important to reduce as much pressure loss as possible by keeping the duct as short as possible with little curves (See Section 5.3.4 Energy Saving Methods in Ventilation System Planning on p.249).
- In order to retain the heat generated by the outdoor unit as much as possible, it is vital to thoroughly insulate refrigerant pipes as well as keeping these pipes as short as possible. It is desirable to use a plan that allows the outdoor unit to be installed as close as possible to the main unit.
- When the outdoor unit receives solar radiation, it works advantageously for heating while disadvantageously for cooling. Therefore, when installing the outdoor unit in a place that is prone to solar radiation, the use of overhangs to protect from solar radiation in summer and receive solar radiation in winter will increase the equipment efficiency.
- If the filter for outdoor air or circulating air is clogged, the equipment performance significantly declines. It is necessary to install the main unit in a place where the filter can be easily cleaned (e.g. on the floor).
- Since the central heating and cooling system sends the air into each room, it also serves as a duct ventilation system. However, it may result in excess or deficiency compared to the required amount of ventilation. If there is deficiency, the use of local ventilation system or other measures is required.
- The whole-building continuous heating and cooling system inevitably requires higher energy consumption than the partial intermittent heating and cooling system. It is necessary to highly insulate the envelope and reduce air leakage (target air tightness of envelope: specific leakage area of house $C = 3 \text{ cm}^2/\text{m}^2$) in order to reduce as much energy consumption as possible.
- In order to reduce the cooling load, it is important to give consideration to the position and size of windows and use solar shading components.

3. Considerations for operation systems (Type 4)

- It is important to reduce the air conditioning load in rooms that are not occupied by lowering the set room temperature for heating (raising it for cooling) and controlling the air flow.
- Frequent cleaning and replacing of the air conditioning or heat exchanger filter leads to the reduction of energy consumption. It is important to encourage the occupants to frequently clean and replace filters.
- Careful attention is required not to raise the room temperature too high in winter, as it not only increases energy consumption but also causes overdrying.
- One of the advantages of the central heating and cooling system is that it is basically a whole-building air-conditioning system and the temperature variation is small between the rooms. However, as temperature variations do not affect rooms that are infrequently used, from the energy efficiency perspective, it is desirable to set the temperature of such rooms closer to the outside air temperature, or to use a control system that can turn off the equipment.

5.2.5 Selecting Auxiliary Heater

- There exist many choices in auxiliary heaters used during the winter months including kotatsu (a small quilt-covered table with an electric heater affixed underneath), electric panel heaters, electric space heaters, electric carpets, ceramic heaters, and halogen heaters. Using these devices may consume more power than heat pump air conditioners used for the same period of time.
- Burning an open flame or heating with an unvented heater that releases exhaust into the room reduces the indoor air quality as fuel is burned indoors. Care is therefore required such as avoiding using such heaters for a long period of time and airing the room frequently when in use.

Comment Power consumption of auxiliary heaters

The figure compares the power consumption of an energy-efficient heat pump air conditioner, an electric carpet and a kotatsu all placed in a living room (floor area: 24 m²). The heat pump air conditioner may consume a significant amount of power immediately after start-up; however, when the temperature stabilizes, it is shown to consume not much more than the electric carpet or the kotatsu at a low setting.

Furthermore, from the point of view of energy efficiency, the low setting is recommended for both the kotatsu and the electric carpet. The electric carpet and the kotatsu may seem energy efficient, as they are localized heaters; however, if left on for a long period of time, they consume more energy than other heaters that heat the entire room.

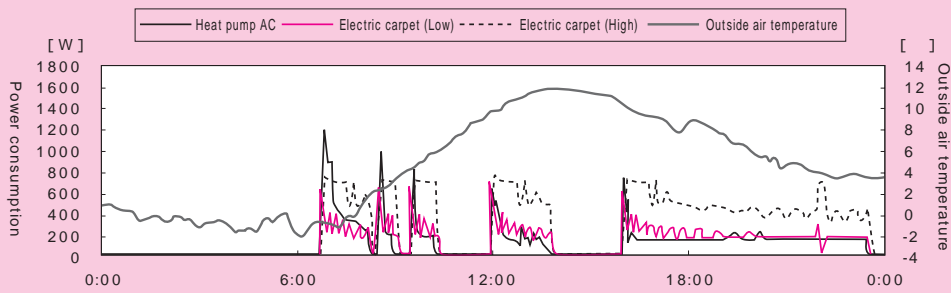

Fig. a Energy consumption comparison between heat pump air conditioner and electric carpet

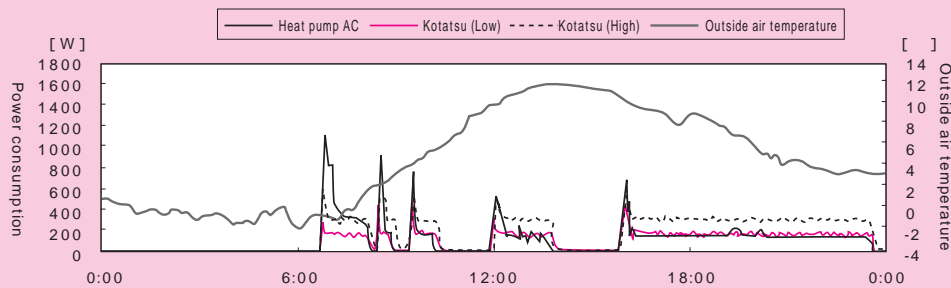

Fig. b Energy consumption comparison between heat pump air conditioner and kotatsu

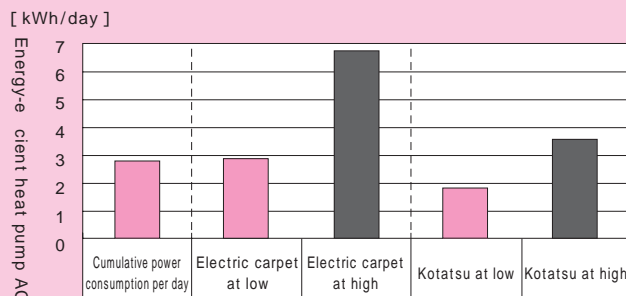

Fig. c Comparison of daily power consumption

Conditions

Building and location: Multi-family residential building in Tsukuba City, Ibaraki Prefecture

Heat pump AC: Energy-efficient 2.2 kW model (COP≈6)

Electric carpet: For use for 3-tatami-mat area (Area: 5 m²;

Rated power consumption: high = 700 W, low = 350 W)

Kotatsu: Square-shaped (Each side measures 75 cm; rated power consumption: 600 W)

The power consumption patterns for the electric carpet and the kotatsu were estimated based on the power consumption measured in the artificial climate chamber (outside temperature = 5°C, indoor temperature = 15°C).

5

Chapter 5
Energy-efficient
Equipment Technology
(Elemental Technology
Application Method 5)

5.3 Ventilation System Planning

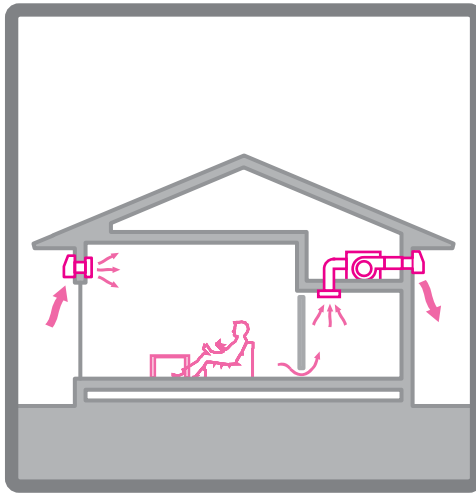

Since the Building Standard Law of Japan was revised in 2003, it became mandatory for virtually all houses to have a mechanical ventilation system as a measure against “sick house” syndrome. Along with placing a limit on the amount that can be used of building materials that release chemicals such as formaldehyde, the Law also requires that a room must have at least 0.5 air changes per hour (ACH) of effective ventilation per hour throughout the year.

It is therefore important, from the point of view of energy-efficient technologies for ventilation systems, to come up with ways to save energy on mechanical ventilation.

5.3.1 Purpose and Key Points of Ventilation System Planning

- The purpose of a ventilation system planning is to ensure that there is at least 0.5 ACH of ventilation required by the Building Standard Law with all openings (windows) closed and to maintain a safe and comfortable indoor air environment in a house.
- The purpose of installing a local ventilation system is to eliminate vapor and odor in moisture-prone rooms such as toilets, bathrooms and kitchens in order to maintain the sanitary levels of the indoor space. However, its ventilation capacity is far greater than the above-mentioned continuous ventilation. Appropriate planning, such as setting up an interlocking air supply opening or installing a timer, is therefore necessary.
- There exist two types of ventilation system: the duct ventilation system and the through-the-wall ventilation system. To save energy using these systems, there is a need for raising the awareness of occupants and plans that focus on supporting maintenance over the years, including the reduction of pressure loss from ducts or outside hoods as well as the selection of high efficiency fans.

5.3.2 Energy Conservation Target Levels for Ventilation System Planning

1. Definition of target levels

- This document provides information on two types of ventilation system: Duct ventilation system (balanced, supply-only and exhaust-only); and Through-the-wall ventilation system (balanced, supply-only and exhaust-only).

As methods and effects of energy conservation differ from one type to the other, energy conservation target levels are determined as follows for each type.

Method 1: Duct ventilation system (balanced, supply-only and exhaust-only)

Level 0	: Ventilation energy reduction	None
Level 1	: Ventilation energy reduction rate	Approx. 30%
Level 2	: Ventilation energy reduction rate	Approx. 50%

- The typical ventilation energy consumption in both Zone VI and V by a duct ventilation system (when performing partial intermittent heating and cooling) was 3.1 GJ (or approximately 5% of the entire energy consumption) in 2000 (See Section 6.1 on p.339).

Method 2: Through-the-wall ventilation system (balanced, supply-only and exhaust-only)

Level 0	: Ventilation energy reduction	None
Level 1	: Ventilation energy reduction	Approx. 20%

- The typical ventilation energy consumption in Zone VI and V by a through-the-wall ventilation system (when performing partial intermittent heating and cooling) was 2.8 GJ and 1.0 GJ respectively in 2000.

2. How to achieve target levels

- The following provides methods to adopt for each type of ventilation system to achieve the targets levels for ventilation system planning. (Table 1, Table 2)

Table 1 Type 1 Target levels for duct ventilation and how to achieve them

Target Level	Energy-saving effect (Ventilation energy reduction rate)	Method to adopt
Level 0	0	
Level 1	Approx. 30%	Method 1: Reducing pressure loss of duct, etc.
Level 2	Approx. 50%	Method 1: Reducing pressure loss of duct, etc. Method 2: Installing high-efficiency device

Table 2 Type 2 Target levels for through-the-wall ventilation and how to achieve them

Target Level	Energy-saving effect (Ventilation energy reduction rate)	Method to adopt
Level 0	0	
Level 1	Approx. 20%	Method 1: Making appropriate connection between the fan and the outside air terminal

- Exhaust-only ventilation type also can serve as local ventilation in rooms such as a bathroom where vapor and odor need to be eliminated by operating the fan for an extended period. Installing this type of ventilation reduces the need to perform local ventilation and overall ventilation and, in consequence, reduces the energy consumption. The overall system also can be made simpler. However, it should be noted that the disadvantage of exhaust-only ventilation system is that opening windows in some rooms decreases the air supply to others.
- In reinforced concrete houses frequently seen in Zone VI, supply-only ventilation type becomes a more attractive option as it supplies air directly into each room without having to address the issue of interstitial condensation in walls. With balanced ventilation, as with supply-only ventilation, direct air supply into each room is ensured; however, the energy-saving advantage of installing a heat exchange type is virtually non-existent in Zone VI.
- Detailed explanations on each method will be provided in “5.3.4 Energy Saving Methods in Ventilation System Planning”.





5.3.3 Steps for Considering Ventilation System Planning

1. Types of ventilation systems

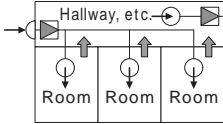
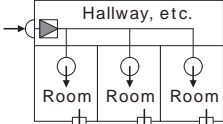
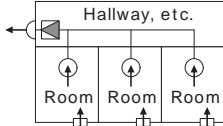
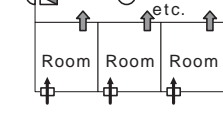
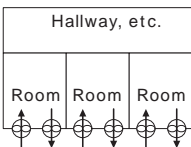
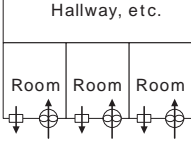
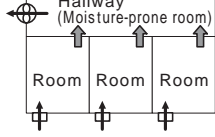
Common types of ventilation systems are listed below in Table 3. Although exhaust-only ventilation is predominantly used in hot humid regions, an overview of common ventilation systems for houses is described here. Understanding all the advantages and points of caution of these systems is essential when selecting an appropriate ventilation system based on the lifestyle of the occupants as well as the floor plan.

Table 3 Common ventilation systems

Types of ventilation system	Advantages	Points of caution	Remarks for planning
Duct balanced ventilation Mechanical air supply per room Centralized mechanical exhaust	 <ul style="list-style-type: none"> Ventilation can be ensured in each room Low operating noise in rooms Attractive interior design If heat-exchange type, protection against cold drafts and reduction of air-conditioning load can be obtained (Zone V) 	<ul style="list-style-type: none"> Duct installation required for each room 	<ul style="list-style-type: none"> A fan unit with an appropriate capacity needs to be selected based on calculations Determine the number of ducts and their length after examining the required ventilation airflow of each room When setting up an exhaust path in moisture-prone rooms, ensure that it is possible beforehand with the specifications of the ventilation device
Duct supply-only ventilation Mechanical air supply per room	 <ul style="list-style-type: none"> Ventilation can be ensured in each room Low operating noise in the room An effective measure against "sick house" syndrome as it limits the airflow coming from the attic or inside the walls Attractive interior design No exhaust duct required 	<ul style="list-style-type: none"> Outside noise can enter through the exhaust opening of each room Less attractive as many holes are made on exterior walls Duct installation required for each room 	<ul style="list-style-type: none"> To take precautions against interstitial condensation in walls during the winter, a certain amount of effective opening area for exhaust is required (Zone V)
Duct exhaust-only ventilation Mechanical exhaust per room	 <ul style="list-style-type: none"> Ventilation can be ensured in each room Low operating noise in the room Attractive interior design Privacy can be ensured, as it does not require door undercuts 	<ul style="list-style-type: none"> Outside noise can enter through the supply opening of each room Less attractive as many holes are made on exterior walls Requires measures against cold drafts at supply openings Duct installation required for each room 	<ul style="list-style-type: none"> If door undercuts are set up, the fresh air supply to each room during the winter months decreases If exhaust is required in moisture-prone rooms as well, use an airflow distribution design that can ensure the exhaust volume in the bathroom
Duct exhaust-only ventilation (combined with local ventilation) Centralized mechanical exhaust	 <ul style="list-style-type: none"> Low cost Simple installation 	<ul style="list-style-type: none"> Outside noise can enter through the supply opening of each room Less attractive as many holes are made on exterior walls Requires measures against cold drafts at supply openings 	<ul style="list-style-type: none"> With a two-storey house that is not air tight, an air supply fan can be added in upstairs rooms in order to ensure ventilation (Zone V)
Through-the-wall balanced ventilation Mechanical air supply/exhaust per room	 <ul style="list-style-type: none"> Ventilation can be ensured in each room Simple installation Privacy can be ensured, as it does not require door undercuts If using heat-exchange type with high ratio of fresh air to total supply air, protection against cold drafts and reduction of air-conditioning load can be obtained (Zone V) 	<ul style="list-style-type: none"> Operating noise may occur in rooms Less attractive as the device is exposed Less attractive as many holes are made on exterior walls Requires measures against cold drafts at supply openings (Zone V) 	<ul style="list-style-type: none"> Address the ventilation in non-habitable rooms not used for extended periods of time, such as hallways and the entrance, by installing local continuous ventilation or other devices
Through-the-wall supply-only ventilation Mechanical air supply per room	 <ul style="list-style-type: none"> Ventilation can be ensured in each room An effective measure against "sick house" syndrome as it limits the airflow coming from the attic or inside the walls Simple installation Privacy can be ensured, as it does not require door undercuts 	<ul style="list-style-type: none"> Outside noise can enter through the exhaust opening of each room Less attractive as the device is exposed Less attractive as many holes are made on exterior walls Operating noise may occur in rooms Requires measures against cold drafts at supply openings (Zone V) 	<ul style="list-style-type: none"> To take precautions against interstitial condensation in walls during the winter, a certain amount of effective exhaust opening area is required (Zone V)
Through-the-wall exhaust-only ventilation (combined with local ventilation)	 <ul style="list-style-type: none"> Cost is low as it is used in conjunction with local ventilation Simple installation Low operating noise in rooms 	<ul style="list-style-type: none"> Outside noise can enter through the supply opening of each room Less attractive as many holes are made on exterior walls Requires measures against cold drafts at supply openings (Zone V) Is prone to clogging by dust that leads to reduced capacity 	<ul style="list-style-type: none"> With a two-storey house that is not air tight, an air supply fan can be added in upstairs rooms in order to ensure ventilation (Zone V)

 Ventilation fan (Duct)
  Ventilation fan (Through-the-wall)
  Door, undercut, etc.
  Indoor air terminal for air supply or exhaust
  Outdoor air terminal for air supply or exhaust
  Air supply or exhaust opening

* Although the supply-only ventilation system (mechanical air supply) is not yet common, it was included in the table as a method to supply outside air in a stable fashion.

2. Steps for considering ventilation system planning

1) Duct ventilation system

- The duct ventilation system offers three major types: balanced, supply-only and exhaust-only. Furthermore, exhaust-only can also be combined with local ventilation with indoor air terminal devices in moisture-prone rooms such as toilets, bathrooms and kitchens. Select a system while closely considering the advantages and the points of caution.
- The placement planning of ventilation system components needs to take into account the need for regular maintenance.
- For the energy efficiency of a ventilation system, one needs to consider not only the performance of the main unit of the ventilation system and its placement, but also the placement of air terminal devices as well as their performance such as loss of pressure loss.
- Consider performing the airflow rate measurement as well as the airflow adjustment after completing the installation of a ventilation system.
- Houses, especially bungalow-style houses and reinforced concrete houses, in hot humid regions where the difference between the outdoor and indoor temperatures is relatively small throughout the year provide favorable conditions for the exhaust-only ventilation system combined with local ventilation.
- Similarly, zones such as Zone VI provide favorable conditions for the exhaust-only ventilation system combined with local ventilation when the house has an open floor plan which takes into account cross ventilation, or when openings between rooms are set up with particular care and ingenuity.

Step 1 Considering ventilation system to be selected

- 1) Confirm the lifestyle of the occupants, the planning of the house, the air tightness of the house, and the method used for heating (Zone V) and cooling.
- 2) Consider types of ventilation system and ventilation paths.

Step 2 Placement planning for ventilation system components

- 1) Consider the placement of outdoor and indoor air terminal devices while taking into account the regular cleaning.
- 2) Consider the placement of the main unit of the ventilation system while taking into account the regular cleaning.
- 3) Consider the placement of the duct while taking into account the structure of the house.
- 4) Reconfirm the ventilation paths.

Step 3 Reconfirming ventilation system's capacity while being mindful of energy efficiency

- 1) Determine the design airflow rate
- 2) Consider ways to minimize pressure loss at ducts and perform pressure loss calculations.
- 3) Select energy-efficient fans while considering their power consumption.

Step 4 Confirming items to be performed during or after installation

- 1) Confirm whether maintenance can be performed or not and make improvements.
- 2) Consider performing the airflow rate measurement.
- 3) Consider performing the airflow rate adjustment.

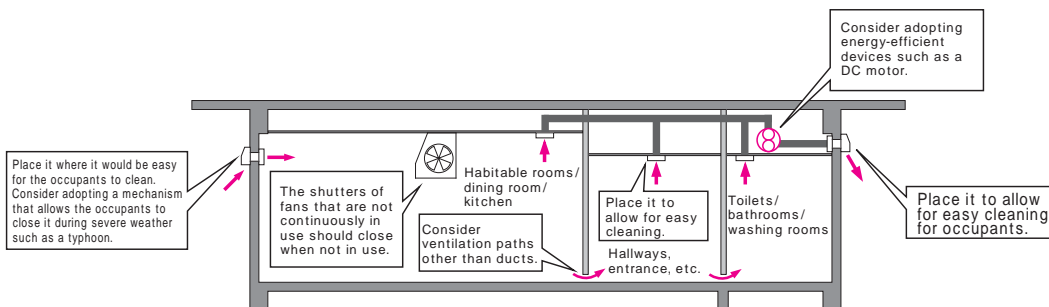

Fig. 1 Example of ventilation system planning (duct exhaust-only ventilation system)

Glossary: Airflow adjustment
For the duct ventilation system, this refers to the change or adjustment made at the degree of opening at air terminal devices in order to maintain a balance in airflow between terminals at the end of branches.

5

Chapter 5 Energy-efficient Equipment Technology (Elemental Technology Application Method 5)

2) Through-the-wall ventilation system

- The through-the-wall ventilation system is comprised of several fans installed in habitable rooms (used for extended periods of time) and moisture-prone rooms.
- There are two types of ventilation planning; one in which the ventilation path is devised for each room and the other where ventilation paths go from habitable rooms towards moisture-prone rooms. Select the system while closely considering the advantages and the points of caution.
- Generally speaking, the through-the-wall ventilation system can experience a significant decrease in air-flow due to accumulated dust on parts such as the grill, which is caused by the system's small pressure difference across the fan unit (the pressure required to feed air). The occupants need to be made aware of the need for regular cleaning.

Step 1 Considering ventilation system to be selected

- 1) Confirm the lifestyle of the occupants as well as the floor plan and air tightness of the house.
- 2) Consider types of ventilation system and ventilation paths.

Step 2 Placement planning for ventilation system

- 1) Consider the use of local fans as part of the continuous overall ventilation.
- 2) Select the main unit and consider its placement while taking into account regular maintenance.

Step 3 Verifying ventilation system 's capacity while being mindful of energy efficiency

- 1) Determine the design airflow rate.
- 2) Consider ways to minimize pressure loss.
- 3) Select energy-efficient fans while taking into account the power consumption and pressure difference across the fan unit.

Step 4 Confirming items to be performed during or after installation

- 1) Confirm whether maintenance can be performed or not and make improvements.
- 2) Consider performing the airflow rate measurement.
- 3) Consider performing the airflow rate adjustment.

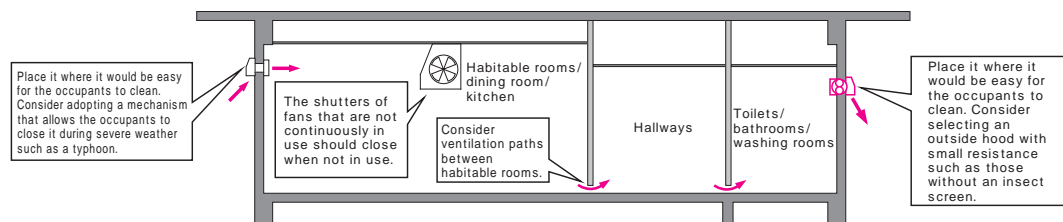

Fig. 2 Example of ventilation system planning (though-the-wall exhaust-only ventilation system)

5.3.4 Energy Saving Methods in Ventilation System Planning

Type 1 Duct Ventilation System (balanced, supply-only and exhaust-only)

Method 1: Minimizing pressure loss at ducts and other areas

When adopting the duct ventilation system, pay special attention to the placement of the ducts and their diameter in an effort to minimize the pressure loss, as the energy required to operate the ventilation will otherwise increase. The following section provides a detailed explanation of the method.

1) Widening the duct diameter

- Some prefer to use slimmer ducts putting too much emphasis on the ease of installation and saving space. It is best to avoid using them as much as possible as it is essential to select a duct diameter appropriate for the airflow. Although in a house it is common to use a diameter of 100 mm to 150 mm for a main duct and 50 mm for a branch duct, a diameter of at least 100 mm is required for both the main and the branch-end duct in order to minimize the pressure loss at ducts. Since the duct ventilation system requires the installation of an air terminal device in each room, it may be difficult to use ducts with a diameter (ϕ) of 100 mm depending on the envelope it is being employed in combination with. If so, use ducts with ϕ 75 mm or more whenever possible.

2) Minimizing the pressure loss with duct length and bends

- You can also limit pressure loss by shortening the duct and reducing the number of bends. This also makes it possible to use smaller fan units.

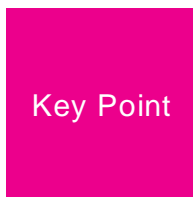

An example of energy-saving effect by widening duct diameter

1) House in Zone VI (reinforced concrete and bungalow)

- The figure below shows the calculation for estimating the energy-saving effect after changing the diameter of the duct in duct placement planning (using an AC motor).
- Plan A uses a main duct with ϕ 100 mm and an indoor-side branch duct with ϕ 50 mm while Plan B uses ϕ 150 mm and ϕ 100 mm, respectively.
- By widening the duct diameter, we can select the model (Model b) with less power consumption that produces the same airflow. In this case, the power consumption was reduced by approximately 40%.

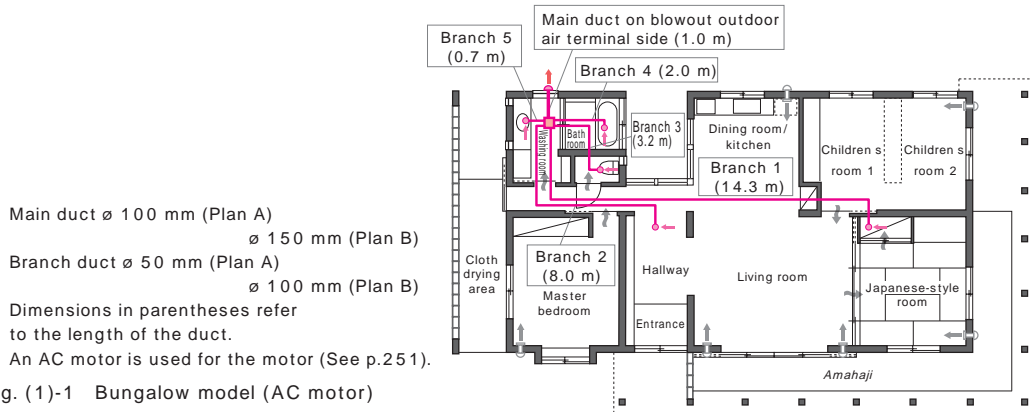

Fig. (1)-1 Bungalow model (AC motor)

Table (1)-1 Comparison of power consumption with different duct diameters (Zone VI)

	Duct placement		Fan unit model	Airflow (m ³ /h)	Pressure loss (Pa)	Power consumption (W)	Power consumption comparison (%)	Specific fan power (w/(m ³ /h))
	Main duct	Branch duct						
Plan A (VI)	100mm	50mm	Model a	160	149	36	100	0.23
Plan B (VI)	150mm	100mm	Model b	160	39	23	64 (36% reduction)	0.14

5

Chapter 5
Energy-efficient
Equipment Technology
(Elemental Technology
Application Method 5)

2) House in Zone V (Wooden, two-storey)

- The figure below shows the calculation for estimating the energy-saving effect after changing the diameter of the duct in the duct placement planning (using an AC motor).
- Plan A uses a main duct with ϕ 100 mm and an indoor-side branch duct with ϕ 50 mm while Plan B uses ϕ 150 mm and ϕ 100 mm, respectively.
- By widening the duct diameter, we can select the model (Model b) with lower power consumption that produces the same airflow. In this case, the power consumption was reduced by approximately 40%.

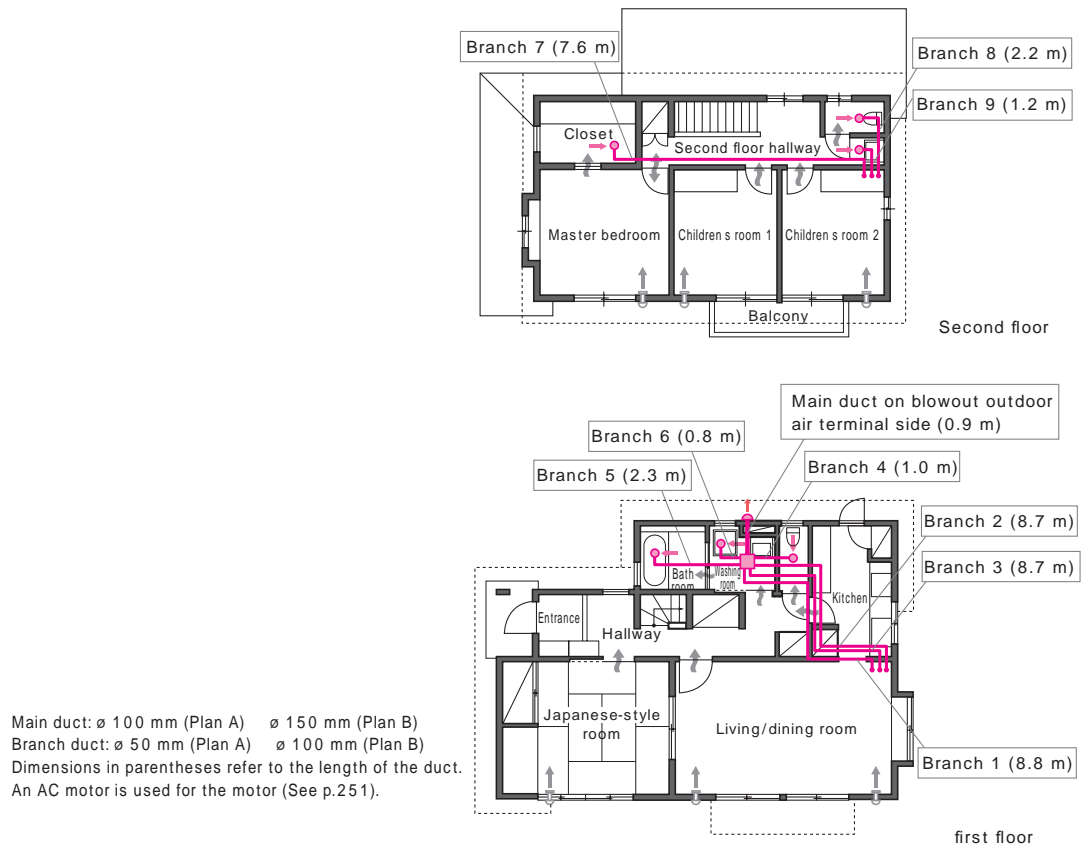

Fig. (2)-1 Two-storey model (AC motor)

Table (2)-1 Comparison of power consumption with different duct diameters (Zone V)

	Duct placement		Fan unit model	Airflow (m ³ /h)	Pressure loss (Pa)	Power consumption (W)	Power consumption comparison (%)	Specific fan power (w/(m ³ /h))
	Main duct	Branch duct						
Plan A (V)	100mm	50mm	Model a	160	149	36	100	0.23
Plan B (V)	150mm	100mm	Model b	160	39	23	64 (36% reduction)	0.14

Method 2: Using high-efficiency devices

It is essential for a ventilation system, which usually operates 24 hours a day, 365 days a year, to increase the energy-efficiency of its fan units. Two types of motors, alternate current (AC) and direct current (DC), are available, of which DC motors are generally considered to be the more energy efficient as their input power is smaller when producing the same airflow.

- In addition to consuming less power, DC brushless motors offer superior control on elements such as the rotation speed, allowing for easier control to achieve a constant airflow or pressure difference across the fan unit. Using this feature, some devices even offer a function to allow for a constant airflow even when the pressure on the fan changes due to factors such as changes in the outside wind pressure.
- Some recent AC motors offer a comprehensive high efficiency. It is therefore advisable to select a fan by consulting many fans' specific fan power ($W/(m^3/h)$), which indicates the amount of input power required to send 1 m³/h of air at its designed airflow rate.
- The formula for calculating the specific fan power is as follows:

Specific fan power = Power consumption ÷ airflow

Power consumption: The W (watt) value listed in the catalog.

Airflow: The m³/h value obtained from the pressure loss calculations. (Note that this airflow does not refer to the airflow when the fan unit is left alone for the test, meaning when ventilation components are not attached.)

- This document refers to systems with 0.2 W/(m³/h) or less as high-efficiency systems.

Key Point

Example of energy-saving effect when using a high-efficiency device

1) House in Zone VI (reinforced concrete and bungalow)

- The figure below shows the estimation calculation of the energy-saving effect after changing the diameter of the duct in duct placement planning using a DC motor. In this example, an operation mode is used that allows the constant airflow. This is a unique function of DC motors.
- Plan C uses a main duct with ϕ 100 mm and an indoor-side branch duct with ϕ 50 mm while Plan D uses ϕ 150 mm and ϕ 100 mm, respectively.
- Plan C, which uses smaller diameters, achieves a reduction in power consumption of approximately 10% compared with Plan A, while Plan D using larger diameters

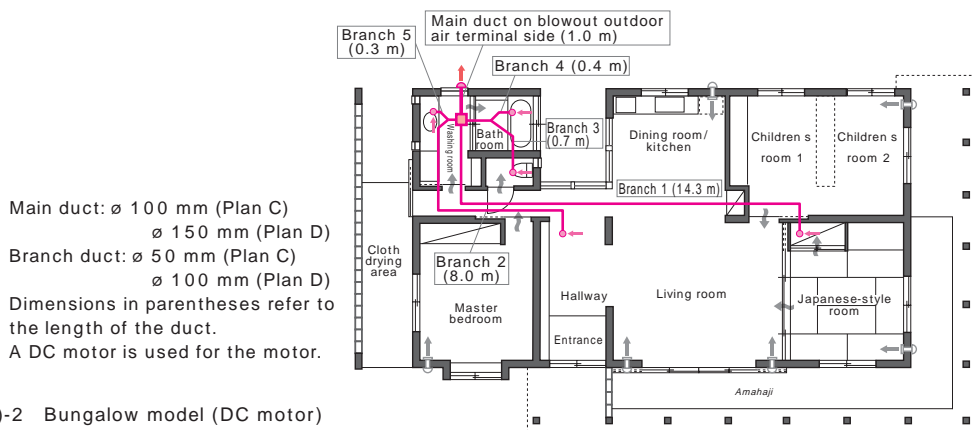

Fig. (1)-2 Bungalow model (DC motor)

Table: Comparison of power consumption with different motors and duct diameters (Zone VI)

	Duct placement		Fan unit model	Airflow (m ³ /h)	Pressure loss (Pa)	Power consumption (W)	Power consumption comparison (%)	Specific fan power (w/(m ³ /h))
	Main duct	Branch duct						
Plan A (VI)	100mm	50mm	Model a	160	149	36	100	0.23
Plan B (VI)	150mm	100mm	Model b	160	39	23	64 (36% reduction)	0.14
Plan C (VI)	100mm	50mm	Model c	160	164	33	92 (8% reduction)	0.21
Plan D (VI)	150mm	100mm	Model d	160	19	17	47 (53% reduction)	0.11

Plan A and B: An AC motor is used; Plan C and D: A DC motor is used.

5

Chapter 5
Energy-efficient
Equipment Technology
(Elemental Technology
Application Method 5)

achieves a reduction of approximately 50%. Note that it is still necessary to keep the pressure difference across the fan unit small even when using a DC motor.

2) House in Zone V (Wooden, two-storey)

- The figure below shows the estimation calculation of the energy-saving effect after changing the diameter of the duct in duct placement planning using a DC motor. In this example, an operation mode is used that allows the user to set the airflow. This is a unique function of DC motors.
- Plan C uses a main duct with ϕ 100 mm and an indoor-side branch duct with ϕ 50 mm while Plan D uses ϕ 150 mm and ϕ 100 mm, respectively.
- Plan C, which uses smaller diameters, achieves a reduction in power consumption of approximately 10% compared with Plan A, while Plan D using larger diameters achieves a reduction of approximately 50%. Note that it is still necessary to keep the pressure difference across the fan unit small even when using a DC motor.

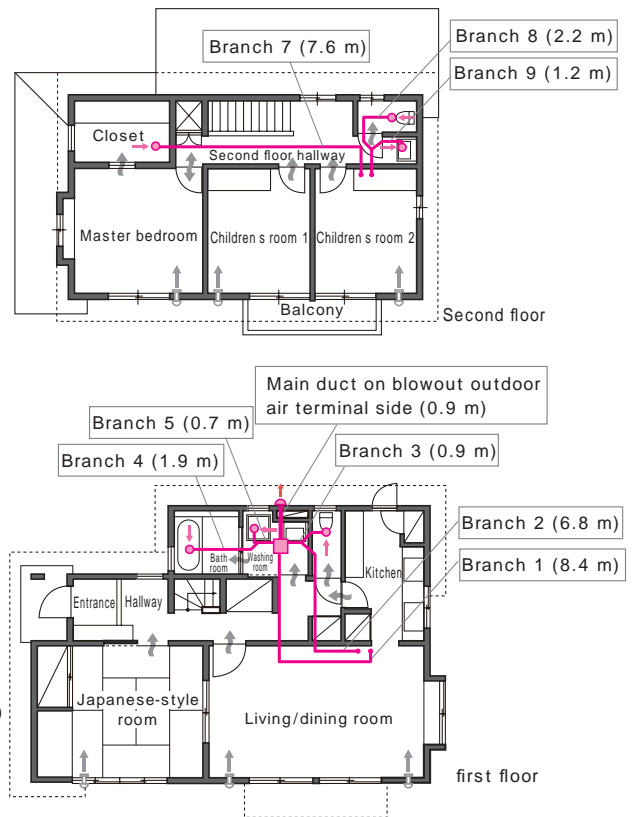

Main duct: ϕ 100 mm (Plan C) ϕ 150 mm (Plan D)
Branch duct: ϕ 50 mm (Plan C) ϕ 100 mm (Plan D)
Dimensions in parentheses refer to the length of the duct.

A DC motor is used for the motor.

Fig. (2)-2 Two-storey model (DC motor)

Table (2)-2 Comparison of power consumption with different duct diameters (Zone V)

	Duct placement		Fan unit model	Airflow (m ³ /h)	Pressure loss (Pa)	Power consumption (W)	Power consumption comparison (%)	Specific fan power (w/(m ³ /h))
	Main duct	Branch duct						
Plan A (V)	100mm	50mm	Model a	160	149	36	100	0.23
Plan B (V)	150mm	100mm	Model b	160	39	23	64 (36% reduction)	0.14
Plan C (V)	100mm	50mm	Model c	160	162	33	92 (8% reduction)	0.21
Plan D (V)	150mm	100mm	Model d	160	17	17	47 (53% reduction)	0.11

Plan A and B: An AC motor is used; Plan C and D: A DC motor is used.

Comment Points of caution when adopting a DC motor ventilation system

Many ventilation systems using DC motors offer superior control performance over systems with AC motors and come with features such as constant airflow control. Maintaining a constant airflow can be energy efficient if the pressure loss at ducts is small; however, this does not always hold true if the pressure loss is significant.

The figure below shows the comparison of power consumption and airflow between the regular mode and the constant airflow mode (300 m³/h) using a kitchen hood fan with a DC motor. With a moderate pressure loss at ducts (here, a 9 meter-duct with three bends is used for estimation), the energy consumption for both modes at 300 m³/h is 22 W but with a

smaller pressure loss, the regular mode experiences an increase in airflow as well as power consumption. However, the airflow of the constant airflow mode is maintained at 300 m³/h, resulting in less power consumption.

Furthermore, when pressure loss is significant, the regular mode's power consumption is low despite not being able to achieve an airflow of 300 m³/h. A constant airflow mode, on the other hand, achieves the airflow requirement but its power consumption is significant. Based on these results, we can conclude that it is vital that the pressure loss be small in order to achieve an energy-efficient operation using a DC motor.

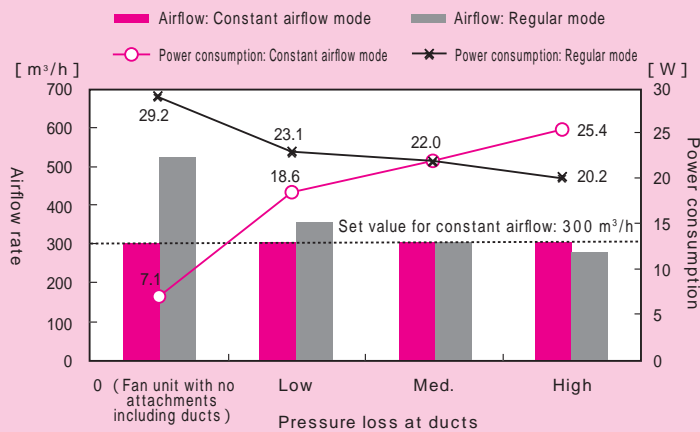

Fig. Relationship between power consumption and constant airflow mode with kitchen hood fan using DC motor

5

Chapter 5
Energy-efficient
Equipment Technology
(Elemental Technology
Application Method 5)

Type 2 Through-the-wall ventilation system (balanced, supply-only and exhaust-only)

Method 1: Appropriately combining fans and outside air terminals

Blower fans used in through-the-wall ventilation systems generally have a smaller allowance (smaller blower fan capacity) for the pressure difference across the fan unit compared to those used in duct ventilation systems. This makes them more susceptible to the influence of pressure loss caused by bird nets or fire dampers attached to the outside hood as well as the outside wind pressure. Furthermore, they require regular cleaning as their airflow can decrease due to accumulated dust.

There are two shapes of the blower fans for through-the-wall ventilation systems: propeller and turbo (Fig. 3). Generally speaking, turbo fans have a higher allowance for the pressure difference across the fan unit and experience relatively fewer problems due to decreases in airflow caused by blocked filters. The fan shapes (propeller or turbo) are indicated in fan manufacturers' catalogs as a reference when selecting.



Propeller fan (left) and turbo fan (right)
Ventilation unit
Fig. 3 Examples of fans for through-the-wall ventilation systems

Key Point

Comparison of turbo fan and propeller fan characteristics

- The figure below shows an example of the characteristics of static pressure (the pressure difference across the fan unit) and airflow in a turbo fan and a propeller fan.
- The airflow for both is approximately 36 m³/h with no attachments, including ducts. However, as turbo fans can operate at a higher pressure difference across the fan unit than propeller fans, the following characteristics can be observed.
 - a. More resistant against outside wind pressure;
 - b. Can be used with hoods with slightly elevated level of pressure loss such as deeper outside hoods;
 - c. Relatively fewer incidents of decreased airflow due to factors such as clogging caused by dust.

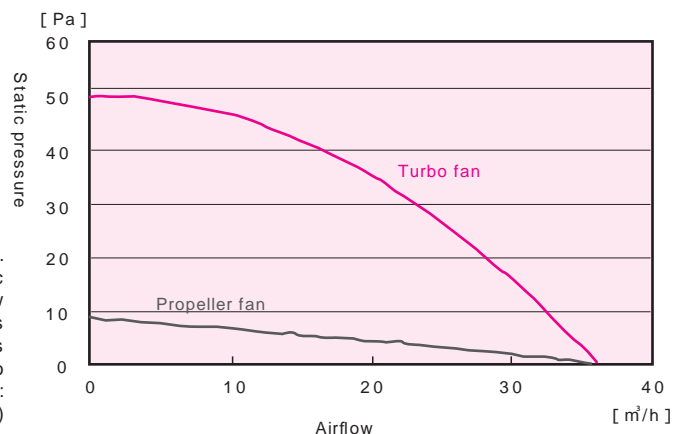

Fig. Comparison of static pressure and airflow characteristics of turbo fans and propeller fans (Airflow of fan unit with no attachments including ducts: 36 m³/h)

Key Point

Information on outside air terminal

- It is vital to select an outside air terminal with small pressure loss as many fan units for through-the-wall ventilation systems are designed to operate with a small pressure difference across the fan unit. A confirmation of an achievable airflow is required based on the pressure loss calculation if you are using an outside air terminal, where airflow when assembled with the fan has not been confirmed by the fan manufacturers.
- For your reference, the table below shows an example of measured value of pressure loss using common outside air terminals. The pressure loss was measured with airflow 40 m³/h. The largest pressure loss was shown to be more than 10 times that of the smallest. These outside air terminals are commonly used, and exhaust fan manufacturers have confirmed their airflow using these combinations; however, smaller design-oriented outside air terminals are known to show even greater pressure loss. It is thus critical to verify whether the airflow has been confirmed by the manufacturer and perform detailed pressure loss calculations.

Table: Specifications and pressure loss of outside air terminals

Specifications of outside air terminal		Pressure loss at 40 m ³ /h*
Air unit A, louver-type		0.2 Pa
Air unit B, deep-type		2.0 Pa
Air unit C, round-type + fire damper + insect screen		2.6 Pa

* The value includes the pressure loss of duct (L: 15 cm, ø: 100 mm).

Key Point

Airflow of fan units for through-the-wall ventilation systems

- The tables below show the results of airflow rate measurements (the airflow when using a duct and outside air terminal) taken in the lab using a propeller fan and turbo fan attached to the above-mentioned outside air terminal.
- In this case, it is shown that airflow decreases by 20% even when using an outside air terminal commonly used with a propeller fan.
- The airflow might not reach the planned airflow rate if the pressure loss calculations are not performed, which indicates the importance of performing the calculations for through-the-wall ventilation systems as well.

Table a Results of airflow rate measurements for propeller fan (Catalog airflow: 36 m³/h)

	Air unit A	Air unit B	Air unit C
Measured airflow	34.6 m ³ /h	32.0 m ³ /h	28.9 m ³ /h
Reduction rate*	4%	11%	20%

Table b Results of airflow rate measurements for turbo fan (Catalog airflow: 36 m³/h)

	Air unit A	Air unit B	Air unit C
Measured airflow	33.9 m ³ /h	32.8 m ³ /h	30.8 m ³ /h
Reduction rate*	6%	9%	14%

* Reduction rate: The percentage of reduction when comparing measured airflow against the catalog airflow.

5

Chapter 5
Energy-efficient
Equipment Technology
(Elemental Technology
Application Method 5)

Comment Air vents on exterior walls with large opening area

The Building Standard Law stipulates that continuous mechanical ventilation can be substituted by an opening on the exterior wall if the effective opening area of the component is 15 cm² ($C = 15 \text{ cm}^2/\text{m}^2$) or more for every 1 m² of floor area and can be kept open at all times.

The energy-saving effect by applying this feature is especially promising in warm regions where the characteristic weather conditions allow for a longer period of time, compared to other regions, when the outdoor air can be brought directly indoors. However, issues such as wind and rain blowing indoors, closing during strong wind, protection against insects and security must be taken into account when selecting the opening component.

Fig. a shows an example of an air vent inte-

grated into the opening (sash). This air vent can maintain an ample effective opening area of approximately 140 cm² when the weather outside is mild. When the wind is strong, its airflow adjustment mechanism (Fig. b) works to prevent excessive ventilation. Furthermore, during a reasonable rain or wind, it can also prevent the rain from blowing indoors even when the doors in the room are open.

There are few actual examples of natural ventilation systems using air vents; however, for a house with a total floor area of 100 m², it would require an effective opening area totaling 1,500 cm², or 11 air vents installed in windows, as shown in Fig. a.



Fig. a
Example of air vent integrated into sash

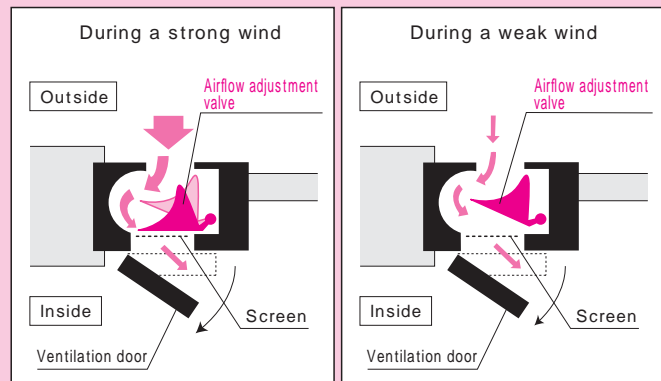

Fig. b
Structure of airflow adjustment mechanism for sash-integrated air vent

5.3.5 Considerations for Ventilation System Planning and Designing

1. Points of caution for ventilation system planning

1) Relationship between local ventilation and continuous overall ventilation

For a local exhaust fan in the kitchen of a house with an insulated envelope, it is essential to not disturb the rooms' thermal environment or other ventilation paths. To this end, it is vital to use an exhaust fan with air supply duct or supply fan or set up a dedicated air-supply opening (Zone V). Furthermore, ensure to select a device capable of efficiently eliminating polluted air (high trapping efficiency) produced by cooking with a small amount of exhaust air, which will be beneficial in terms of power consumption or reducing cooling and heating energy.

When the overall ventilation is performed by exhaust-only ventilation, depending on the air tightness of the housing, more air can come in through cracks than through the air supply openings. To ensure a balanced air supply into the rooms through planned air-supply openings, creative measures are required besides relying simply on the envelope's performance. For instance, a device can be installed to close the shutter when a local ventilation system, independent of the overall ventilation system, is not in use.

2) Ventilation system planning that takes maintenance into account

(1) Main unit

It is desirable to set up the continuous ventilation system where maintenance work can be performed with ease. Fig. 4 and Fig. 5 show examples of ventilation systems that can be installed on a wall. As they are not buried into the ceiling, filter and blade inspections or cleaning can be performed with ease. Even when this particular setup is not possible, some creativity is needed to facilitate inspections and maintenance work.



Fig. 4 Wall-mounted ventilation system

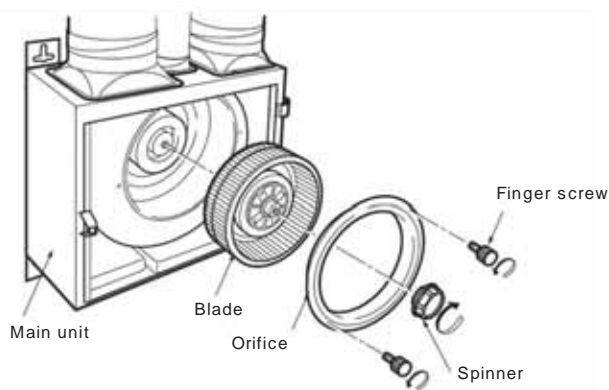

Fig. 5 Inspecting filter and blades

Ventilation devices that are hidden in places such as an attic make maintenance work difficult to perform and the occupants may not recognize dirt accumulating on parts including the filter. This will be a subject of improvement for the near future.

The following are three actions that can be taken in the planning phase regarding maintenance.

- Fans with filters require regular filter cleaning while fans without filters need regular cleaning of the blades of the blower fan. In either case, select a device while taking into account the routine cleaning required.
- Use creative ways to make cleaning easier. For instance, a ventilation system can be set up in a storage room or attic where the system can be exposed. The main ventilation unit can also be set up vertically.
- Let the occupants know that the system requires regular cleaning.

5

(2) Air terminal device

The maintenance required for the outside air terminals (outside air intake openings), which tends to be overlooked, needs to be taken into account. Insect screens are often seen on outside air intake openings. These screens also require regular maintenance, without which the ventilation capacity is reduced (Fig. 6). On the second floor, by principle, the units need to be set up in such a place as a balcony, which is accessible for cleaning. Furthermore, on the ground floor, units tend to be installed where they cannot easily be reached from the ground; however, they still need to be installed in such a place where they can be accessed for cleaning purposes with a stepladder or the like.

Some air terminal devices have no insect screen on the device itself but rather a filter is installed on the indoor main unit. Ease of maintenance is again an issue to be considered in this case, and a bird net should be set up on the exterior wall to prevent birds from entering the duct.

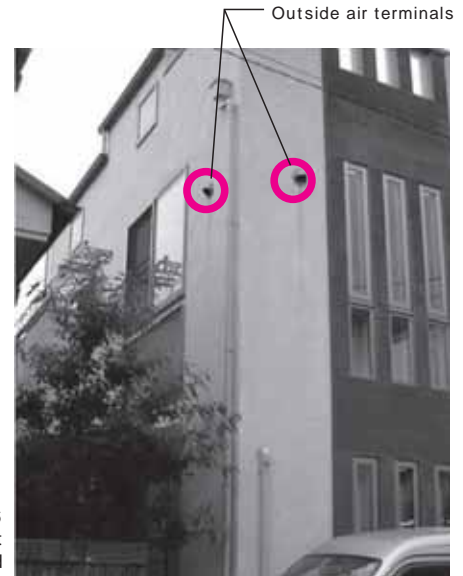

Fig. 6
Example of outside air terminals set up where it cannot be reached

Key Point

Survey result on frequency of cleaning of ventilation system

- The result of the survey conducted with 1,500 respondents throughout Japan demonstrated that virtually nobody cleaned the outside air terminals (hood).
- The figure below shows the cleaning frequency of the indoor air unit (including the fan's main unit) as well as the outside air terminals (hood). Although approximately 70% of respondents clean the indoor air unit once a year or more, more than 80% answered that they do not clean the outside hood including 16% who could not identify the outside hood in a photo. This result reiterates the importance of installing the air terminal device where it can be reached to facilitate regular cleaning.

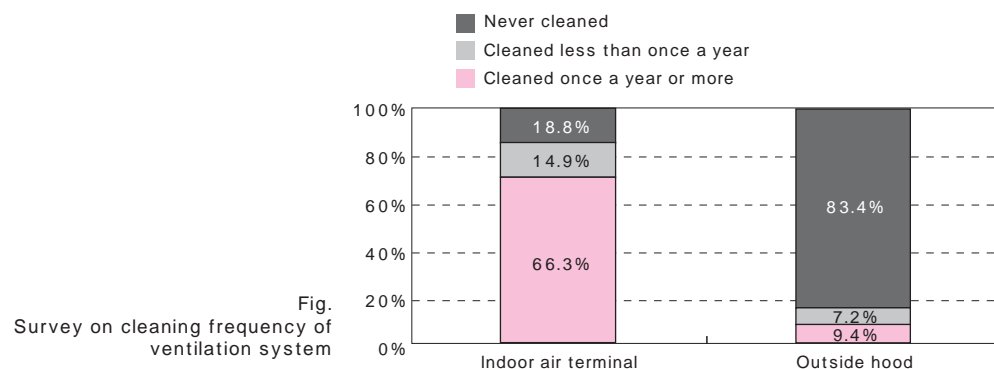

Fig. 6
Survey on cleaning frequency of ventilation system

3) Considerations regarding interference such as outside wind

Some through-the-wall exhaust fans (through-the-wall ventilation fans) designed for local ventilation come with an electronic airtight shutter. An airtight shutter is installed to prevent draft when the device is not in use; however, it consumes power during the period when it is open. Select a model without the electric airtight shutter when planning for a continuous operation to save energy. Keep in mind, however, that models with electric airtight shutters are sometimes selected if they are not to be used continuously during the winter months to reduce ventilation airflow.

By using a deep or wind-resistant air vent that has an outside hood or a damper (Fig. 7), you can ensure a relatively stable airflow without interference from the outside wind in regions that see many typhoons where outside wind is strong throughout the year. Furthermore, using salt-resistant outdoor air terminal device in regions adjacent to the ocean, especially if the sea breeze is also strong, can minimize rust.



Fig. 7 Example of air vent with damper preventing interference from outside wind

Comment Energy-efficiency and local ventilation system

Our survey results indicate that the length of usage per day for local ventilation systems such as kitchen hood fans and exhaust fans in toilets or bathrooms varies significantly depending on the individual. After analyzing the data, we estimated the approximate length of usage per day for a kitchen hood fan to be 100 minutes, 80 minutes for an exhaust fan in a toilet, and 200 minutes for an exhaust fan in a bathroom. In the bathroom exhaust fans, which are presu-

ably used to dehumidify the room, are used by more than half of the respondents for over three hours a day. The power consumption by local ventilation is significant even when using a ventilation system with an energy-efficient DC motor, accounting for roughly half of the overall ventilation. Energy-efficiency is going to be a subject of improvement for local ventilation systems that operate intermittently.

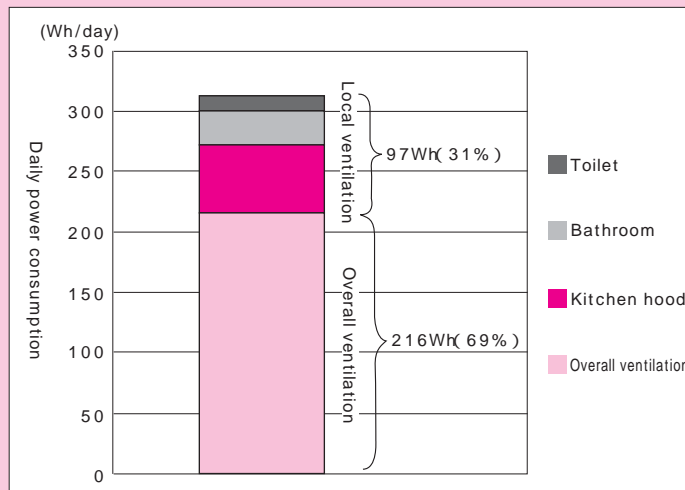

Fig. Example of daily power consumption by ventilation (using exhaust-only ventilation with DC motor for overall ventilation)

5

Chapter 5 Energy-efficient Equipment Technology (Elemental Technology Application Method 5)

4) Considerations regarding air supply opening placement and air supply methods

Consider adopting devices such as the radiant type (supplied air is diffused in all directions along the wall) to prevent cold air from directly entering the living space (Fig. 8).

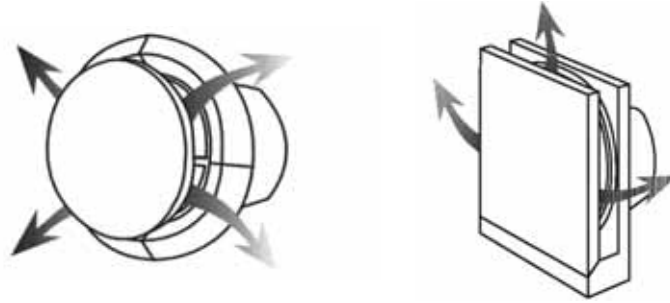

Fig. 8 Example of radiant-type air supply opening

5) Method and effects of airflow rate measurement

The most important aspect of planned ventilation is to ensure that the ventilation system can provide the planned ventilation airflow as well as the ventilation performance. To this end, it is vital to validate the airflow of the ventilation system after installation.

It is very common to use an airflow meter with a hood attached, as comparatively speaking they are readily available, when performing an airflow rate measurement on site of the ventilation system installation. As shown in Fig. 9 and Fig. 10, this airflow rate measuring instrument, generally known as “hood airflow meter”, is applied to either the indoor or outdoor air terminal device (such as indoor inlet/outlet terminal or outdoor hood) of the ventilation system.

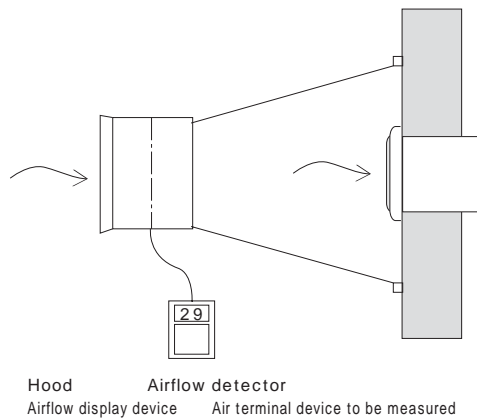

Fig. 9 Example of setup of airflow rate meter



Fig. 10 Airflow rate measurement being performed

Performing airflow rate measurements is effective in confirming that the planned airflow rate has been obtained; however, it can also serve as a tool to uncover problems by providing airflow measurements of air terminal devices. For instance, if a particular branch experiences low airflow, the branch may have a problem, while if the general airflow is low, it could be traced back to the main duct or the main fan unit.

Furthermore, if the results of the airflow rate measurements exceed the planned airflow rate, an adjustment can be made accordingly to lower the power consumption and the ventilation load to achieve more energy saving effect.

Comment Airflow rate measurement using k-factor method

Measuring airflow rate may at times be difficult due to the placement of the air terminal devices or, if indoors, furniture may obstruct access to the indoor air terminal device. When situations such as these arise, the k-factor method offers an alternative way to make taking the airflow rate measurements possible with a small margin of error.

The k-factor method is a method of airflow rate measurement employing a micro differential-pressure meter. Although there are no standards regarding this measuring method in Japan, it is already being used to measure airflow rate overseas, especially in Northern European countries.

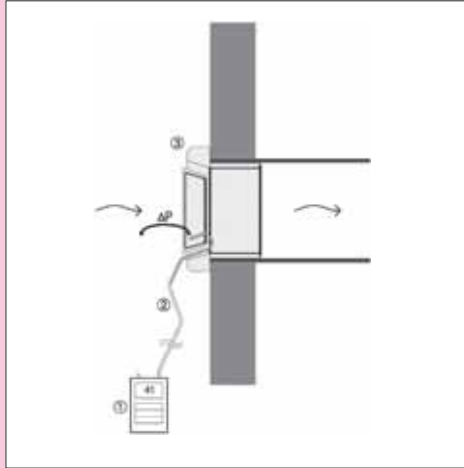

Fig. a Example of measuring instrument
Micro differential-pressure meter
Tube for measuring pressure
Ventilation system component

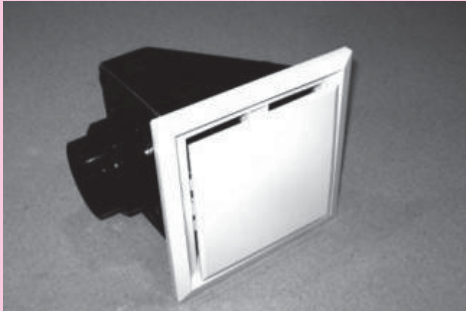

Fig. b Example of indoor air terminal device designed for k-factor method and actual measurement being taken

2. Design that takes into account the regular cleaning

1) Considerations for reduced capacity caused by dirt adhering to through-the-wall fans

The fan in Fig. 11 was used for two years in a toilet and found to have reduced airflow of roughly 75% of the initial measurement. When the ventilation capacity is reduced due to dirt adhering to the fan, not only is the ventilation rate reduced, but also the fan is consuming energy needlessly. To maintain the energy-saving effect, regular maintenance is key as cleaning will keep the device operating under the conditions similar to those when it was initially installed. Even when a filter is installed, neglecting maintenance will cause the filter to clog, which in turn will prevent the device from achieving the planned ventilation rate.

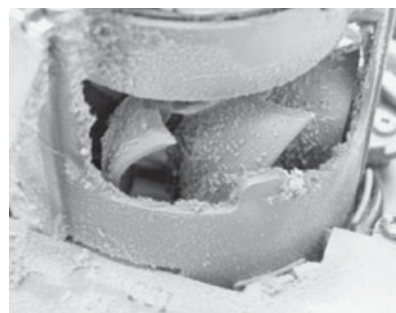
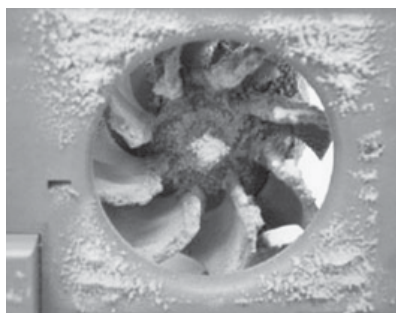

Fig. 11
Example of dirt
adhering to through-
the-wall fan
(Filterless model used
for two years intoilet)

Front of the fan

Inside the pipe

5

Chapter 5 Energy-efficient Equipment Technology (Elemental Technology Application Method 5)

2) Consideration regarding ease of maintenance

Performance can be maintained over the long term by selecting a device that people can easily clean and otherwise maintain (Fig. 12 and Fig. 13).



By selecting a device with an inlet opening that is protected by a filter, the amount of dirt on or damage to blades and clogging of the insect screen attached to the outdoor hood can be reduced. Dust that accumulates on the filter surface can be easily removed by using a vacuum cleaner.

Fig. 12 Cleaning filter of through-the-wall exhaust fan

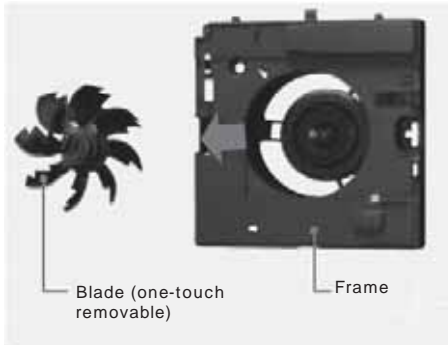

If the model selected can be easily disassembled, cleaning the blades of dust is possible. Some devices have blades that can be removed without the use of tools.

Fig. 13 One-touch removable blades

3) Addressing the dirt in duct exhaust-only ventilation systems

Generally speaking, there are two types of maintenance required by a 24-hour overall ventilation system for a house: light maintenance performed by the occupants such as filter cleaning, and heavy-duty maintenance performed by professionals such as motor replacement and duct cleaning.

Duct exhaust-only ventilation systems commonly have filters in components such as indoor air terminal devices and main units, allowing occupants easy indoor access for cleaning. Although duct systems tend not to experience reduced airflow due to accumulated dust, not performing regular cleaning will eventually lead to difficulties in reaching the planned ventilation rate. Furthermore, installing attachments such as an insect screen on the outdoor hood may lead to reduced airflow caused by indoor dust being trapped and accumulating inside (Fig. 14).

Let the occupants know that placing furniture blocking the indoor air terminal device would not only hamper the cleaning but also prevent the system from reaching its planned ventilation volume.

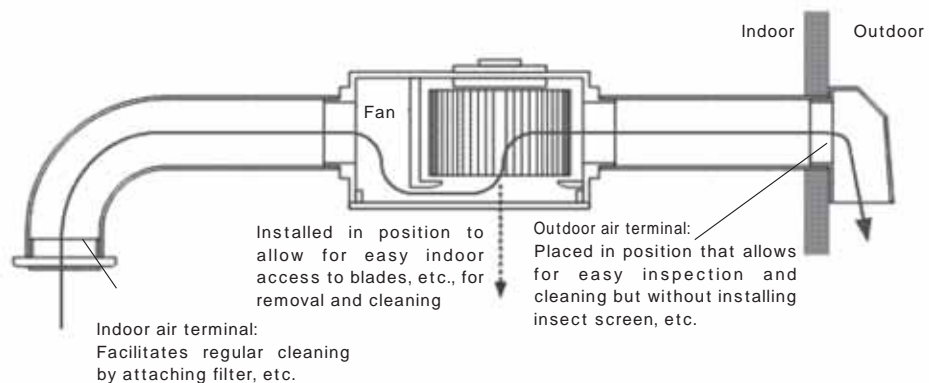

Fig. 14 Structure of duct exhaust-only ventilation system and measures for cleaning in each part

Key Point

Changes in airflow and specific fan power of ventilation system

- The figure below shows the change in ventilation airflow and specific fan power before and after the indoor air terminal device and the fan blades were cleaned for the first time after being used as 24-hour ventilation in a bathroom for two years.
- After the cleaning, the airflow increased roughly 30% while the specific fan power decreased by roughly 20%.

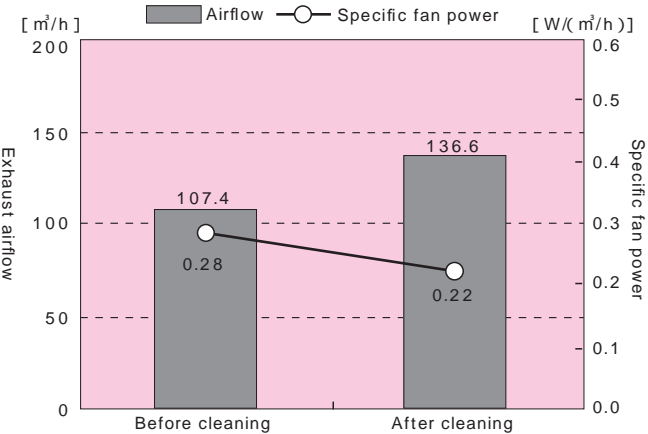
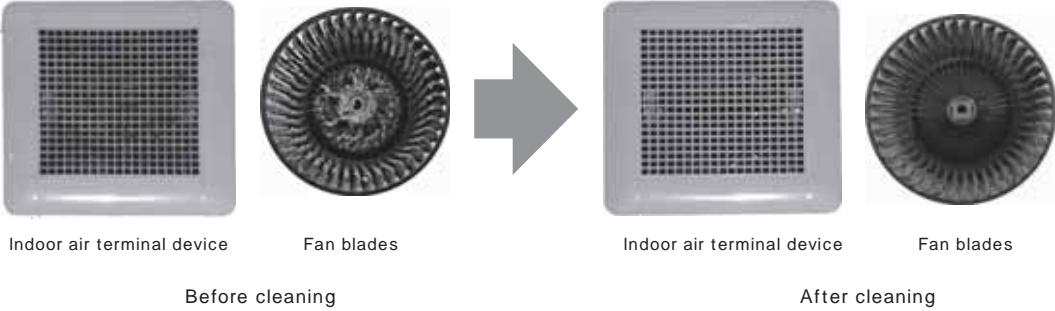
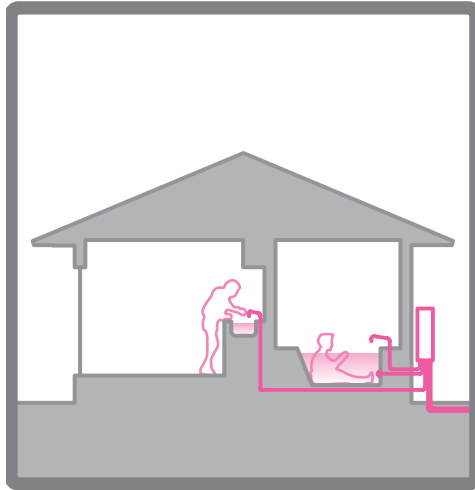

Fig. Changes in airflow and specific fan power before and after cleaning

5

Chapter 5
Energy-efficient Equipment
Technology
(Elemental Technology
Application Method 3)

5.4 Domestic Hot Water System Planning



Domestic hot water systems have become indispensable in the way we live our lives today. Hot water accounts for a significant portion of household energy consumption. It is thus vital to make use of energy-efficient technologies when planning a domestic hot water system.

This chapter provides organized explanation of energy saving methods for domestic hot water system planning.

5.4.1 Purpose and Key Points of Domestic Water Heating System Planning

- The purpose of the energy saving methods for domestic water heating system planning presented in this document is to realize highly convenient living whereby hot water is provided in the required place, time and amount with minimal energy by applying various cutting-edge technologies.
- As hot water accounts for a significant portion, generally about 20 to 30% in hot humid regions, of the overall household energy consumption, the value of energy saving design in domestic hot water systems cannot be stressed enough.
- The most common method today is to set up a large heat source outside the house and connect it to the domestic hot water system through plumbing. This type, called the “central domestic hot water system” (Fig. 1), is the one presented in this document.
- The central domestic hot water system domestic hot water system is comprised of three parts: a heat source, a piping system, and finally, a domestic hot water faucet and a bathtub. Energy saving measures must be considered for each of these elements (Fig. 2).
- The heat source of a domestic hot water system can be gas, oil or electricity.
- When using gas or oil as the heat source, the hot water is heated by burning fuel; however, due to limitations of devices, not all the energy from the fuel can be used to heat the water. The resulting excess heat not used for heating is primarily emitted in the form of exhaust gas. However, recently a so-called “latent heat recovery” device, which uses this excess heat within the exhaust gas to increase the efficiency of the system, is becoming more commonplace.
- Electric heaters have been the most common electrical heat source used in systems; however, in recent years, a high-efficiency heat pump device, which collects heat from the air, has rapidly become more popular. If choosing to use an electricity-based system, the heat pump device will offer energy saving effects.
- It is extremely important to understand these characteristics when selecting a system type, based on various factors such as weather conditions, family composition and how the system will be used, to ensure that the heat source with the highest efficiency possible is selected.
- Energy saving effects can be dramatically improved by using a solar water heating system (See Section 3.5 Solar Water Heating on p.102). However, it is difficult to rely on it alone as bad weather and winter months can be problematic. It is therefore used in conjunction mainly with gas and oil heat sources.
- Although the “central domestic hot water system” is convenient, its piping tends to be long, which generally increases heat loss. It is therefore essential to pay careful attention to energy saving measures for the piping when designing the system.
- In order to increase energy saving effects, it is also necessary to consider adopting a faucet appropriate for saving hot water. A highly insulated bathtub is also effective as it reduces the need to reheat bathwater (this habit might be limited to the Japanese bathing style, in which family members usually share hot water in the bathtub when bathing).

It is currently extremely rare to combine an electric water heater with a natural refrigerant heat pump, a high-efficiency water heater, with a solar water heating system; however, some new products have been launched and may become more widely commercially available.

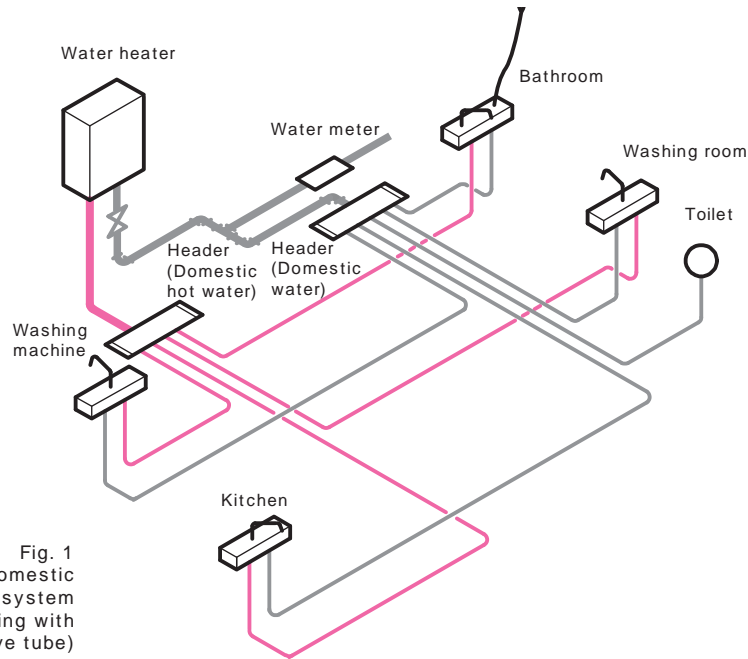

Fig. 1 Overview of central domestic hot water system (header-conduit piping with sleeve tube)

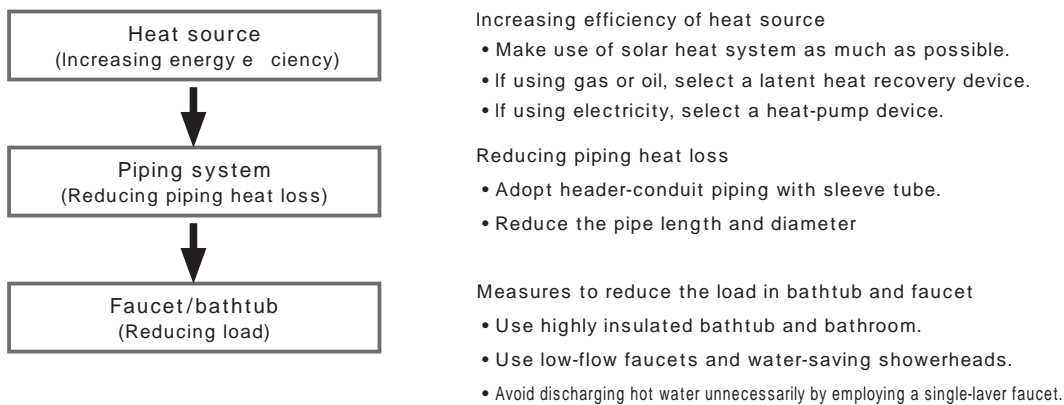

Fig. 2 Structure and energy saving measures of central domestic hot water system

5.4.2 Energy Conservation Target Levels for Domestic Hot Water System Planning

1. Definition of target levels

- Energy conservation target levels for domestic hot water system planning are divided into Level 1 to Level 4 as shown below. These levels indicate the reduction rate in energy consumption of a domestic hot water system.

Level - 1	: Domestic hot water energy increase	10% or more
Level 0	: Domestic hot water energy reduction	None
Level 1	: Domestic hot water energy reduction rate	At least 10%
Level 2	: Domestic hot water energy reduction rate	At least 20%
Level 3	: Domestic hot water energy reduction rate	At least 30%
Level 4	: Domestic hot water energy reduction rate	At least 40%

- In 2000, the typical domestic hot water energy consumption was 13.8 GJ in Zone VI (approximately 21% of total energy consumption) and 19.2 GJ in Zone V (approximately 28%). (See Section 6.1 on p.339).
- Level 0 applies to a case in which no energy saving method was adopted related to domestic hot water when using a conventional gas water heater. Levels 1 through 4 indicate the domestic hot water energy reduction rate compared to Level 0. Any target level can be achieved by adopting domestic hot water planning methods.

5

Chapter 5 Energy-efficient Equipment Technology (Elemental Technology Application Method 3)

Electric water heater with a natural refrigerant heat pump

This document refers to an electric water heater that uses a natural refrigerant heat pump as “electric water heater with a natural refrigerant heat pump”. As heat pump is often abbreviated as “HP” and virtually all natural refrigerants are made of carbon dioxide (CO₂), it is abbreviated mainly as CO₂ HP throughout this text. Since CO₂ is a type of greenhouse gas, it may give the impression of being counterproductive to measures against global warming; however, at approximately 1 kg, the amount of CO₂ that fills the CO₂ HP is miniscule. Fluorocarbon refrigerant, the other type of refrigerant commonly used in heat pumps, creates several hundred to several thousand times more greenhouse effect. Comparatively speaking, CO₂ can therefore be considered to have virtually no environmental burden.

2. Requirements for achieving target levels

- As shown on Table 1, this document presents three examples of domestic hot water system planning methods. The guidelines for energy saving effects (domestic hot water energy reduction rates) using each method are as shown on the table.

Table 1 Domestic hot water system planning methods and energy saving effects

Method	Description of method	Energy saving effect (Domestic hot water energy reduction rate)
Method 1	Using solar heat (adopting solar water heater or solar system)	
Method 2	Using high-efficiency water heater	Latent heat recovery gas/oil water heater
		Electric water heater with a natural refrigerant heat pump (CO ₂ HP)* Only when boiling mode serves as “energy-efficient” mode
Method 3	Considering energy-efficient design/construction for each component of domestic hot water system (thermal insulation of piping/bathtub, hot water saving devices, etc.)	

- Method 1 is a type of domestic hot water system planning that makes use of solar heat. Please refer to Section 3.5 Solar Water Heating. An explanation is provided on Method 2 and Method 3 in “5.4.4 Energy Saving Methods for Domestic Hot Water System Planning”.

3. How to achieve target levels

- Table 2 shows the relationship between the energy conservation target levels for domestic hot water system planning and the methods. Each method can be adopted on its own; however, combining them will enhance the energy saving effect.

Table 2 Target levels for domestic hot water system planning and how to achieve them

Target level	Energy saving effect (Domestic hot water energy reduction rate)	Application of method
Level - 1	Increase of 10% or more	Method 2 (CO ₂ HP used for “Maximum boiling mode” and “Maximum late-night only mode”)
Level 0	0	Uses a conventional domestic hot water system device only and does not apply any energy saving methods.
		Method 2 (CO ₂ HP used for “Medium late-night only mode”)
Level 1	10% or more	Method 2 (latent heat recovery gas/oil water heater)
		Method 2 (CO ₂ HP used for “Medium boiling mode (Zone V))
		Method 3
Level 2	20% or more	Method 2 (latent heat recovery gas/oil water heater) + Method 3
		Method 2 (CO ₂ HP used for “Medium boiling mode” (Zone VI))
Level 3	30% or more	Method 2 (CO ₂ HP used for “Energy efficient mode” (Zone V))
Level 4	40% or more	Method 1
		Method 2 (CO ₂ HP used for “Energy-efficient mode” (Zone VI))
		Method 2 (CO ₂ HP used for “energy-efficient mode”) + Method 3

* The energy saving effect of CO₂ HP will vary depending on the boiling mode. See p.279 for details.

5.4.3 Steps for Considering Domestic Hot Water System Planning and Requirements for Selecting System Type

1. Steps for considering hot water system planning

Step 1 Considering and verifying selection requirements for domestic hot water system type

Consider and verify selection requirements such as site conditions and how the occupants use their domestic hot water system for selecting a domestic hot water system type.

- 1) Verify the site conditions.
- 2) Verify how the domestic hot water system will be used.

Step 2 Selecting domestic hot water system type and consider its design/construction, etc.

Select the appropriate domestic hot water system based on requirements in Step 1 and consider adopting energy-efficiency design, construction and the like.

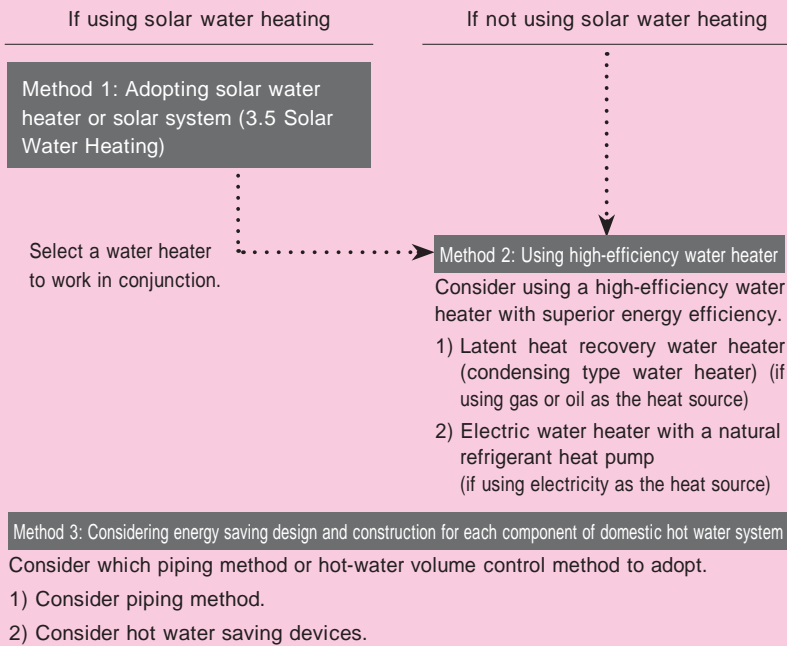

2. Requirements for selecting domestic hot water system method

1) Regarding site conditions

(1) Condition of the building site and other factors

When considering the use of solar water heating, it is important to verify whether or not sunlight can be secured. Verify the condition of the surrounding area of the building site (See Section 3.5.3 Steps for Examining Solar Water Heating on p.107).

(2) Condition of energy supply

Options available for heat source can be limited by whether or not processed natural gas is supplied to the site.

(3) Water pressure

If there is no pump attached to the water heater, it may be difficult to set up a bathroom on the second floor. Other limitations may also occur.

(4) Set-up space

Verify the size of the device to be installed and the space available. If using a domestic hot water system that comes with a hot water tank, the availability of set-up space for the tank becomes an important condition.

(5) Measures against salt damage

When installing a system on a site near the ocean, select a device specifically designed to resist and prevent salt damage. These devices are treated with rust-preventive agents and other special treatments.

(6) If using solar water heating system

If using solar water heating system, it is vital to consider the efficiency of the heat source for water heaters working in conjunction with solar water heating systems.

5

2) Selecting appropriate device capacity according to occupants habits and intended use

When selecting a water heater, it is necessary to understand how the occupants actually consume hot water so as to select a device with an appropriate capacity.

(1) Family composition (Number of people)

- Fig. 3 shows the result of a survey on typical hot water consumption according to the household size. All the numbers represent the average hot water volume per day (converted to 40°C) for an entire year.
- The average for a one-person household was approximately 180 L and increased as the household size increased. A four-person household consumed approximately 450 L.
- On the other hand, the average consumption per person showed that a person in a four-person household consumed approximately 112 L while a person in one-person household simply consumed all of the hot water, which was 180 L. This result shows that hot water consumption would be comparatively higher for smaller households. We are currently seeing an increase in the number of smaller households (one- or two-person), which is a source of concern as it may become one of the factors in increased hot water consumption.
- Furthermore, hot water consumption varies greatly even among households of the same size. Fig. 4 shows the distribution of hot water consumption (annual average) among one- and two-person households and three- and four-person households. In both cases, the distribution is spread out with some households consuming more than twice the average consumption.
- If the occupants are known at the time of designing, it is useful to engage in discussions with them on their hot water consumption in advance as hot water consumption varies greatly among households. The verification is also recommended regarding their past fuel consumption (electricity, gas, and oil) or water meter readings (normally for a two-month period, the average consumption for a four-person household is 48 to 60 m³, half of which can be presumed to be for hot water).

(2) Intended use

- It is vital to verify the functions of the bathtub (automatic filling or reheating) as well as whether the water

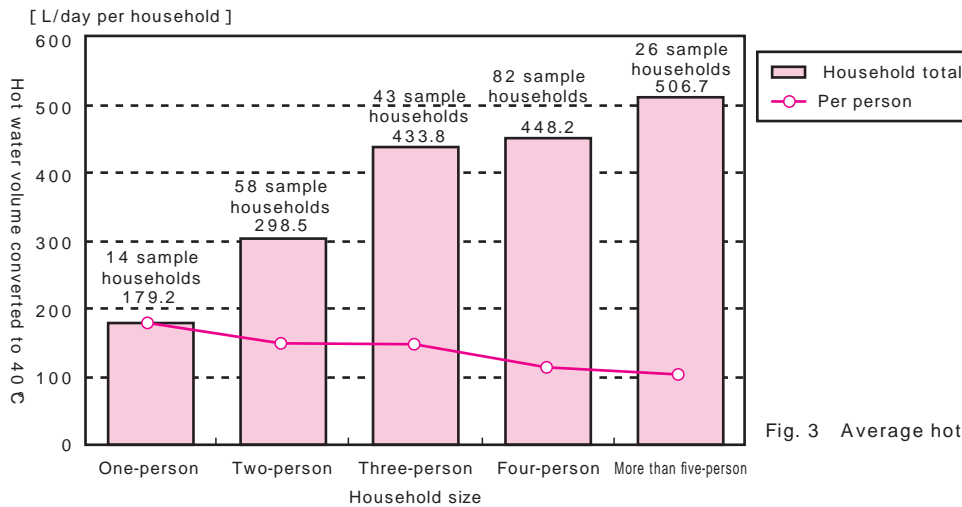

Fig. 3 Average hot water consumption by household size

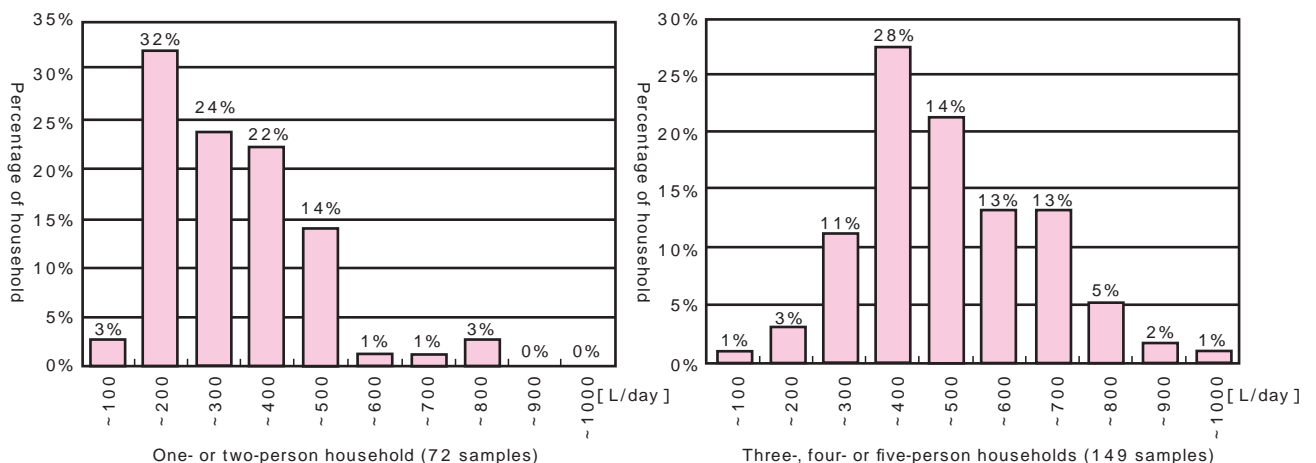

Fig. 4 Distribution of hot water consumption*

* Surveys mainly conducted on detached or multi-family houses in Kanto and Kinki regions

Source: Research Committee on Planning/Evaluation Methods for Energy-efficient Domestic Hot Water System for the New Generation, The Center for Better Living

heater will be used in conjunction with heating (floor heating) to be able to select a water heater with an appropriate capacity and functions. The capacity of a water heater generally refers to the instant heating capacity for instant water heaters (most gas and oil water heaters) and the hot water storage capacity for the hot water storage type (electric water heaters and CO₂ HPs). For instant water heaters, the higher the instant heating capacity the bigger the discharge of domestic hot water would be. For hot water storage water heaters, the higher the hot water storage capacity, the more hot water would be available for use during the day as they can store more hot water using late-night power.

- Bath tub functions are standard nowadays and there are very few water heater models that are domestic hot water supply-only without bathtub function.

(3) Determining capacity for hot water storage heaters

- Most water heaters employing electricity as a heat source (such as electric water heaters and CO₂ HPs) are of the hot water storage type that uses late-night power. With this type of water heater, it is important to select an appropriate capacity for the hot water storage tank as this limits the amount of hot water available for use during the day. The most common capacities for a hot water storage tank are 300 L, 370 L, and 460 L. Although very rare, there are also tanks with a capacity of less than 200 L or more than 500 L.
- As the hot water storage tank stores water at a high temperature (65°C or more), the hot water is used after mixing it with tap water. This means that the actual amount of hot water available for use is even greater than the capacity of the tank.
- A typical four-person household usually selects 460 L as the capacity for their electric water heater while 370 L is the most common for CO₂ HPs. However, as mentioned previously, hot water consumption varies greatly among households. Select larger hot water storage tank if the hot water consumption is expected to be high.
- If a household consumes extremely large or extremely small amount of hot water, a hot water storage heater is not an appropriate choice.

(4) Determining capacity of instant water heaters

- Most water heaters employing gas or oil as a heat source are of the instant type. As this type heats water at the time of supply, the amount of hot water available at any given instant is limited.
- The instant heating capacity of a water heater is customarily expressed in numbers (#) with bigger numbers being capable of simultaneously supplying more hot water for multiple uses. Currently, #32 is roughly the maximum available for home use.
- However, a more common capacity (#20 to 24) is more than enough to handle the hot water consumption of an entire four-person family. Even during the winter months, it can supply more than enough hot water for the shower and the kitchen simultaneously.
- The capacity of the reheat function of a bathtub is usually around 10 kW, which is more than enough capacity for a typical household. (As reheating reduces the energy efficiency, it is recommended to avoid using it whenever possible.)
- If space heating function by hot water is available, it is necessary to determine the needed capacity after considering factors such as the size of the area to be heated and the insulation performance of the house.
- Unlike the hot water storage type, the instant type does not put a limit on the amount of hot water it can supply per day. It is common to select this type for small households (one- or two-person) with low hot water consumption as well as households with extremely high hot water consumption.

3) Relationship with costs

- Although the initial cost of energy-efficient domestic hot water systems can be relatively high, it is best to select the type while considering the reduction in CO₂ emissions as well as the reduction in running cost.
- Using hot water saving devices such as thermostatic mixer faucets or devices with shut-off valves is highly recommended as there is very little initial cost associated with them and their effectiveness has been validated.
- Some government agencies and local governments offer subsidy programs from which people can benefit. It is therefore necessary for the designers to be thoroughly familiar with these programs from the point of view of the client.

* In the past, electric water heaters could not heat water during the day when they ran out of hot water as late-night electricity contracts were the standard. The capacity for those water heaters was therefore set well above the actual need to make allowance for extra water. On the other hand, the use of CO₂ HPs is usually based on a time-of-day contract, which allows heating during the day. For this reason, it is common for CO₂ HPs to have a smaller capacity than electric water heaters so as not to store an excessive amount of hot water.

* “Domestic hot water capacity #24” denotes that the water heater has the capacity to heat 24 L of water from 15 °C to 40 °C in one minute. “#1” is equivalent to 1.75 kW

5

3. Styles and types of water heater

1) Styles of water heater

There are a variety of styles of water heater currently available. Table 3 shows some of them and the most common fuel and characteristics.

Table 3 Styles, fuel and characteristics of water heaters

Instant type	Gas and oil	<ul style="list-style-type: none"> •The burner heats the water in the boiler the moment the hot water is supplied. •The control of the hot water discharge temperature has vastly improved due to technological advances. •Very popular due to its large output and the compact size.
Hot water storage type	Electric water heater (not mentioned in this document)	<ul style="list-style-type: none"> •Mainly uses late-night power to heat and store hot water heated by an electric heater. •Requires a large set-up space as the size of the hot water storage tank is substantial. •Compared to heat pumps, its efficiency is significantly low as it uses an electrical resistor.
	CO ₂ HP	<ul style="list-style-type: none"> •Similar to the electric water heater, it uses late-night power; however, the efficiency during the heating has greatly improved by using a CO₂ heat pump. •Note that its efficiency is heavily dependent on the boiling mode. •As it uses a natural refrigerant (CO₂), its global warming coefficient and the environmental burden are smaller compared to the conventional fluorocarbon refrigerant. •Requires a large set-up space as the size of the hot water storage tank is substantial. •Becoming rapidly more common in recent years.
	Heat pumps other than CO ₂ HP	<ul style="list-style-type: none"> •Commonly use fluorocarbon refrigerant. •Tend to have a lower efficiency at high temperature compared to those using CO₂ refrigerant.
Instant hot water storage type	Oil	<ul style="list-style-type: none"> •As it is relatively difficult to control combustion with oil, it tends to have a smaller hot water storage tank to control the temperature change. •As it is becoming more common to use oil for instant water heaters, the number of new installations for this type is decreasing.

2) Functions of water heaters

Water heaters possess a variety of functions (Table 4). In the past, it was common to have different models and functions for different purposes. For instance, the bathroom would have a bath boiler while a small water heater would serve the kitchen. However, now that the central domestic hot water system is becoming more commonplace, we are seeing one main water heater equipped with all the functions. One notable characteristic unique to Japan is that we tend to focus more on the functions related to bathing.

- There are two types of piping for the bathtub system: single-pipe and double-pipe. The single-pipe system limits the number of functions as it does not allow circulation.
- A domestic hot water faucet dedicated to the bathtub was a must in the past; however, we are now seeing many bathtubs without a faucet.
- In recent years, an increasing number of water heaters are being equipped with a space heating function partly due to the popularity of floor heating. Table 4 shows a variety of functions that enhance the convenience of the water heater. It should be noted, however, that if not used properly, these functions could be detrimental to the energy-efficiency performance by, for example, disturbing the temperature stratification in the hot water storage tank.
- For more detail on energy-efficient bathing, see Key Point on p.285.

Table 4 Functions of water heaters

Domestic hot water supply function		•This function directly supplies hot water from the hot water pipe and faucet. Models offering only domestic hot water supply as a function are now rare as the central domestic hot water system has become commonplace.
Bathtub functions	Automatic filling	•This function fills the bathtub with hot water at the set temperature to the set water level.
	Keep-warm (double-pipe only)	<ul style="list-style-type: none"> •This function maintains the set water temperature for a set period of time after filling. •Some of the water in the bathtub is returned to the water heater and released after being reheated. •As this function requires hot water circulation in the bathtub, the bathtub piping must be double-pipe. •Some water heaters can also maintain the water level.
	Reheat (double-pipe only)	<ul style="list-style-type: none"> •This function resembles the "keep warm" function but it reheats water that has reached a low temperature long after filling (i.e. remaining water from the day before). •As this function requires much more reheating capacity than the "keep warm" function, some models equipped with the "keep warm" function do not offer the "reheat" function.
	Hot water adding	•This function adds a set amount of high-temperature hot water to cold water in the bathtub.
	Water level maintenance	•This function adds hot water when the water level in the bathtub decreases.
Heating functions	Low temperature (60°C or less)	•This function heats and circulates hot water mainly for floor heating.
	High temperature (Approx. 80°C)	•This function circulates and supplies high-temperature hot water to a bathroom heater/dryer or a radiator.

5.4.4 Energy Saving Methods in Domestic Hot Water System Planning

Method 1 : Adopting a solar water heater or a solar system

See Section 3.5 Solar Water Heating on p.102.

Method 2: Using a high-efficiency water heater

Table 5 shows a comparison of the energy saving effects by heat source for the types of high-efficiency water heaters recommended in this document and the traditional domestic hot water system.

Table 5 Recommended high-efficiency water heaters and energy saving effects

Heat source	High-efficiency water heater (standard name given in parentheses)	Energy saving effect*	
Gas	Latent heat recovery gas water heater (Eco Jozu)	Approx. 15%	
Oil	Latent heat recovery oil water heater (Eco Feel)	Approx. 15%	
Electricity	Electric water heater with a natural refrigerant heat pump (CO ₂ HP and Eco Cute)	Maximum boiling mode: late-night only maximum mode	-10% (increase)
		Late-night only medium mode	0%
		Medium boiling mode	10% (Zone V) 20% (Zone VI)
		Energy saving mode	Approx. 35% (Zone V) Approx. 40% (Zone VI)

*1: The calculation for the energy saving effect for gas and oil water heaters took power consumption into account.

*2: The energy saving effect for CO₂ HP may vary depending of its boiling mode. See p.279 for details.

Key Point

Efficiency of water heater

- Although efficiency values indicated in catalogs are used when designing, it should be noted that these values are not based on imitated actual usage as they are measured under certain set conditions relatively easy to recreate (Table a). Furthermore, these values cannot necessarily be compared since their definitions also vary depending on the type of heat source used by the water heater.
- Catalog efficiency figures have been difficult to compare under common conditions in the past as they vary from model to model. This document therefore evaluates the performance of various types of water heaters uniformly by conducting tests based on actual usage.

Table a Conditions for measuring efficiency shown in catalogs

Type	Standard name	Characteristics and points of caution
Gas water heater	Japanese Industrial Standards JIS S 2109 Domestic gas water heater	<ul style="list-style-type: none"> • "Heat efficiency" is the ratio between the amount of hot water heating and the amount of gas heat generated when the water heater was continuously operated at its maximum capacity (rated). • Does not take into account the actual usage including the intermittent partial load. • Does not include power consumption. • Outside conditions, etc., are set and do not take into account seasonal changes, etc. • The efficiency for reheating is referred as "bath heating efficiency", which is the efficiency to heat the bath water (increase in water temperature by 30 °C for 180 kg of water between 10 °C and 25 °C).
Oil water heater	Japanese Industrial Standards JIS S 3031 General Provisions on Testing Methods for Oil Heating Appliances	<ul style="list-style-type: none"> • The ratio between the amount of hot water heating and the amount of oil heat generated when hot water was continuously operated at its maximum capacity (rated). • Does not take into account the actual usage including the intermittent partial load. • Does not include power consumption. • Outside conditions and other factors are set and do not take into account seasonal changes, etc.
Heat pump water heater (CO ₂ HP and others)	Japan Refrigeration and Air Conditioning Industry Association JIRA4050:2007 Domestic heat pump water heater	<ul style="list-style-type: none"> • Provides information on items related to safety and efficiency regarding domestic heat pump water heaters including CO₂ HPs. • Efficiency of a heat pump alone under four different conditions (COP for energy consumption efficiency). • Conducts hot water output for a day of imitated actual usage (IBEC L mode) and calculates the annual efficiency of the entire system (annual performance factor of hot water supply or APF). • For APF, the boiling mode is generally presumed to be the factory-set mode (Indicated in the catalog when it differs). • Needs to be converted by primary electricity conversion as it uses secondary electric conversion for both COP and APF.

* Efficiency and energy consumption figures mentioned in Chapter 5 and Chapter 6 were obtained from the results of tests conducted based on imitated actual usage. The values thus may vary from the catalog values shown on the left. Note, however, that the section on the heat balance of domestic hot water systems in Chapter 5 uses the catalog values shown on the left for clarity and convenience.

5

Chapter 5
Energy-efficient Equipment
Technology
(Elemental Technology
Application Method 3)

- As catalog efficiency values for water heaters such as “heat efficiency”, COP, and APF are measured under specific conditions, they generally tend to differ from the efficiency values when the water heaters are actually used. Furthermore, regional differences in weather conditions are not taken into account, either.
- The efficiency values used to estimate energy consumption, as well as actual energy consumption, were all obtained by conducting tests with actual usage in mind. Regional differences in weather conditions have also been taken into account. The values shown therefore will differ from the catalog values.
- IBEC L mode has been long used in the past as the typical hot water discharge pattern (domestic hot water supply mode) that imitates the actual consumption of domestic hot water; however, this mode was created based on the hot water consumption of a four-person household 30 years ago and no longer fits our current lifestyle. For instance, the number of hot water discharges was presumed to be only 13 times a day.
- This document uses “Corrected M1 mode”, which is a model for a hot water discharge mode that imitates actual usage. This mode is based on a typical four-person household of today and takes into account the latest information to create the most standardized values for averages, day-to-day changes, and distributions throughout the day. “Corrected M1 mode” is comprised of six typical days with actions during the day set in detail (Table b). It also recreates short bursts of hot water discharges common in real life and counts a maximum 38 hot water discharges a day. The average value for “Corrected M1 mode” for a four-person household is set at 450 L/Day, which is the actual average, as shown in the figure on the next page. Furthermore, daily changes are designed to be standardized over the course of the month.
- Tests were mainly conducted between 2004 and 2008 at the Validation Experiment Building of the Building Research Institute, an independent administrative agency in Tsukuba City, Ibaragi Prefecture. We recreated the efficiency during actual usage by actually opening and closing faucets according to the above-mentioned “Corrected M1 mode”. The results obtained were then adjusted for differences in weather conditions and noted by region.

5

Chapter 5 Energy-efficient Equipment Technology (Elemental Technology Application Method 3)

Glossary: Balanced flue water heater
A balanced flue water heater is a type of water heater that utilizes natural convection, as opposed to mechanical power for air supply and exhaust when burning gas. Because of its use of natural convection, its air supply and exhaust opening (flue) tends to be large. In the past, a bathtub water heater was often installed next to the bathtub. During renovation, it is often the case that the bathtub water heater is eliminated to make more room in the bathroom and a “through-the-wall” type compact water heater is fitted into a large air supply exhaust opening in its stead.

1. Latent heat recovery gas water heater (“Eco Jozu”)

- The “heat efficiency” of a conventional gas water heater for the domestic hot water function is approximately 83% while that of a more efficient latent heat recovery gas water heater is approximately 95%. (The heat efficiency is a type of efficiency based on the amount of gas heat set by the Japanese industrial Standards (JIS S2109) and does not include power consumption.)
- The reason for its increased heat efficiency is that it recovers the heat created by vapor (latent heat) mixed in the exhaust gas instead of eliminating it as a conventional water heater would do. This recovered heat is then used to preheat the tap water (Fig. 5).
- Fig. 5 is based on the test results using “Corrected M1 Mode”, which imitates the actual usage. The efficiency during the actual usage is slightly lower than the catalog efficiency; however, it still demonstrates high efficiency at approximately 90% even after including power (secondary energy conversion).
- The “bath heat efficiency” based on the reheating of bath water is approximately 80%, which is quite similar to that of a conventional water heater. This is due to the decreased efficiency of latent heat recovery during circulation heating.
- The Energy Conservation Law (Law Concerning Rational Use of Energy) defines the energy consumption efficiency of gas water heaters and these values are generally indicated in catalogs as well. It is obtained by calculating the weighted average of “(hot water) heat efficiency” and “bath heat efficiency” at the ratio of 3.3:1.
- The appearance, size and the installation site of a latent heat recovery gas water heater are very similar to those of a conventional instant gas water heater (Fig. 6). Its price has come down considerably since it was first introduced in 2000 when it was significantly more expensive than a conventional type. Since the price difference between the two types are now small, we hope that latent heat recover gas water heaters will become more and more popular.
- Although most latent heat recovery gas water heaters are equipped with bathtub functions as well as space heating by hot water, we are also seeing recently a few models that perform water heating function only. Some models are compact-sized such as the through-the-wall type balanced flue water heater that fits into an exhaust opening (Fig. 6).
- The domestic hot water capacity of many models is #24, which is more than enough to use for a shower during the winter when the domestic hot water temperature decreases.
- Its efficiency when in use is barely influenced by the amount of hot water consumption, which is a common characteristic of all instant water heaters. Compared to conventional water heaters, this type is able to maintain higher efficiency regardless of the family composition of the household where it is installed or its hot water consumption. However, instant water heaters tend to experience a decrease in efficiency when a



Fig. 6
Example of
latent heat
recovery gas
water heater



Through-the-
wall type

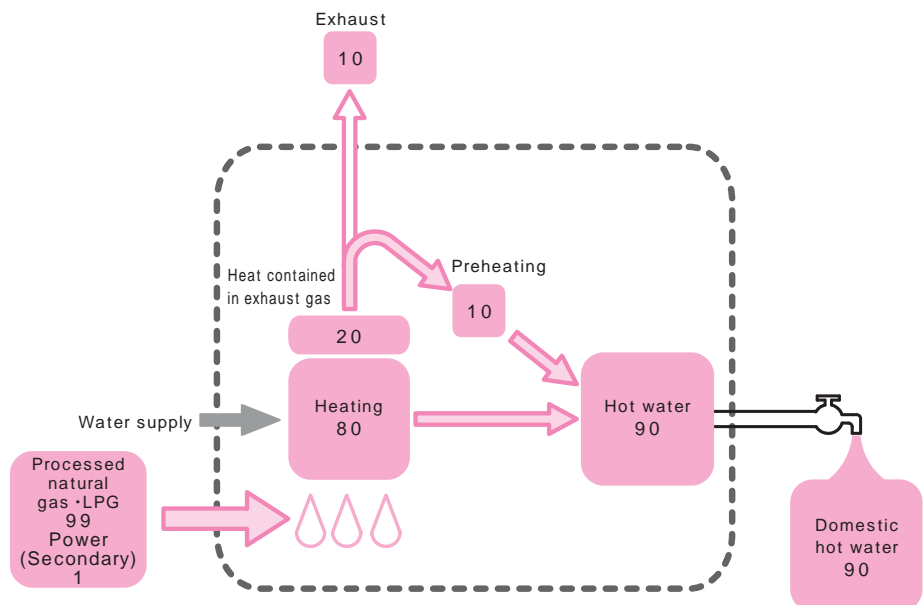

Fig. 5 Secondary energy flow of latent heat recovery gas water heater (Estimated annual average values for Kagoshima)

small amount of hot water was discharged in bursts. It is important to be mindful not to inadvertently discharge hot water if using a single-lever faucet (See Key Point on p.287).

- As it recovers latent heat contained in vapor, the vapor is eliminated from the device as water (drainage water). It is necessary to take this into consideration when designing so that the drainage water can be appropriately eliminated, for example, through a rainwater drainpipe.
- The drainage water is acidic in nature; however, the device has an integrated neutralizing agent that renders it harmless.

2. Latent heat recovery oil water heater (“Eco Feel”)

- The continuous water heating efficiency of a conventional oil water heater is approximately 86% while that of a more efficient latent heat recovery oil water heater is approximately 95%. (The continuous water heating efficiency is a type of efficiency set by the Japanese industrial Standards (JIS S3031) and does not include power consumption.)
- The technologies to increase the heat efficiency are the same as those for latent heat recovery gas water heaters. It recovers the heat created by vapor (latent heat) mixed in the exhaust gas instead of eliminating it as was done in the past. This recovered heat is then used to preheat the tap water (Fig. 7).
- This device was first introduced in 2006 and is relatively new to the market. Not many models are therefore available. Although domestic hot water supply-only models (Fig. 8) were dominant in the beginning, we are now seeing models with bathtub functions as well as space heating by hot water.
- As with latent heat recovery gas water heaters, the drainage water treatment needs to be taken into consideration.
- Fig. 7 is based on the test results using “Corrected M1 Mode”, which imitates the actual usage. The efficiency during the actual usage is slightly lower than the catalog efficiency; however, it still demonstrates high efficiency at approximately 90% even after including power (secondary energy conversion).

Fig. 8
Example of latent
heat recovery oil
water heater

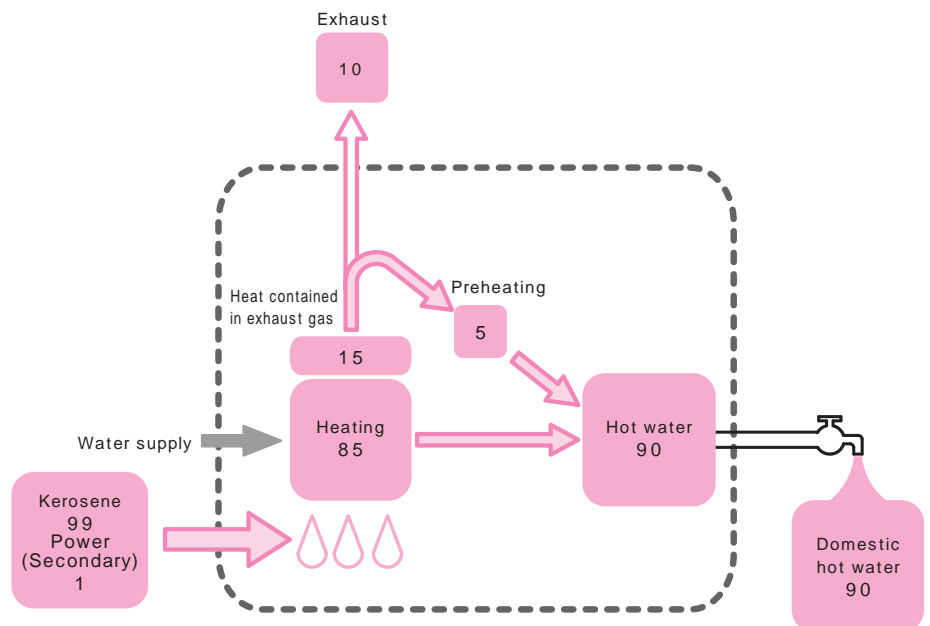

Fig. 7 Secondary energy flow of latent heat recovery oil water heater (Estimated annual average values for Kagoshima)

3. Electric water heater with natural refrigerant heat pump (CO₂ HP: “Eco Cute”)

- A heat pump is a highly efficient heat source that has traditionally been used for space heating and cooling devices such as air conditioners. By compressing the refrigerant and transferring the heat through the heat collection section and the heat releasing section, it makes it possible to obtain more heat than the energy consumed. For home use, an electric motor is generally used for power (Fig. 9).
- As a heat pump is a device that transfers heat, it requires a heat source from which this can be collected. Generally, the most common hump pump is the air type that uses the outside air as its heat source; however, the efficiency of the heat pump can fluctuate significantly according to the season as the outside air

* It was difficult in the past to reach a high temperature necessary for water heating with a heat pump using fluorocarbon refrigerant. Some models do continue to use fluorocarbon refrigerant today; however, they cannot be labeled “Eco Cute” as they do not use natural refrigerant.

5

Chapter 5 Energy-efficient Equipment Technology (Elemental Technology Application Method 3)

- goes through considerable seasonal changes in temperature.
- In hot humid regions where the outside air temperature is high throughout the year, the heat collection from the air is easier and the energy efficiency remains high. It can therefore be said that CO₂ HP is a type most suited for hot humid regions.
 - With the introduction of CO₂ HP, which uses high-pressure CO₂ refrigerant, domestic hot water supply through a heat pump became possible. Generally, CO₂ HP can provide hot water between 65 and 90°C (HP hot water discharge temperature).
 - Since it first appeared on the market in 2001, its efficiency has rapidly improved. Its functions have also multiplied and models that offer not only water heating but also bathtub functions as well as space heating by hot water are becoming more and more prevalent.
 - Those equipped with a bathtub circuit can be divided into two categories: single-pipe system (reheating and keep-warm functions not available) and double-pipe system (reheating and keep-warm functions available).
 - It is necessary to ensure that there is enough set-up space after taking into consideration the size and the shape of the heat pump unit as well as the hot water storage unit that comprise the electric water heater with a natural refrigerant heat pump (Fig. 10).
 - A common CO₂ HP is the “single cylinder” type, which has a cylindrical hot water storage tank. Another type, called the “double cylinder” type with two small side-by-side hot water storage tanks, aims to keep the size of the hot water storage unit compact; however, as it increases the surface area, it also increases the heat loss.
 - Using a heat pump will achieve greater efficiency than that of a heater-type; however, it is a hot water storage type and uses late-night power and it is therefore essential, for energy-saving purposes, to select an appropriate tank capacity according to the household where it is being installed.
 - The typical household size is currently set for a three-person household, and 300 L, 370 L, and 460 L are most common. The general recommendation for two- to four-person households is 300 L, for three- to five-person households, 370 L, and for four- to six-person households, 460 L. The product range of those possessing a capacity of 200 L or less as well as 500 L or more are limited. In consequence, there is currently no recommended product for one- or two-person households.
 - As the hot water storage tank stores water at a high temperature (usually 65°C or more), the hot water is used after mixing it with tap water. This means that the actual amount of hot water available for use is even greater than the capacity of the tank.
 - Unlike the instant type, its efficiency tends to fluctuate significantly depending on how it is used (See Key Point on p.279).
 - Fig. 9 is based on the test results using “Corrected M1 Mode”, which imitates actual usage. It demonstrates that, by collecting heat from the air, the power required is considerably reduced compared to heater type electric water heaters.

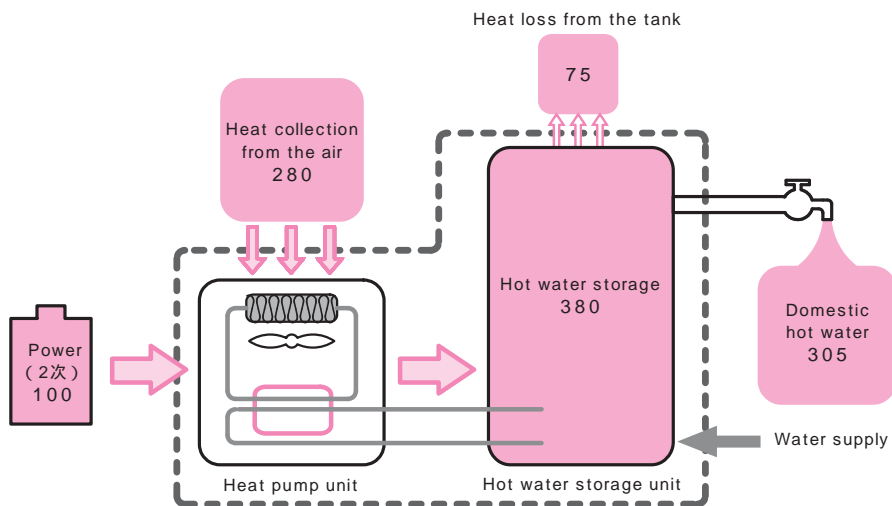

Fig. 9 Secondary energy flow of electric water heater with natural refrigerant heat pump (Estimated annual average based on 2005 model of “Energy-saving mode” by Company A in Kagoshima)



Key Point

Understanding efficiency according to fuel type

The efficiency evaluation figures do not mean the same thing for gas, oil and electricity. This is why, for example, the heat efficiency of a gas or oil water heater cannot be compared to the annual performance factor of hot water supply (APF) of a CO₂ HP.

- “Power 100” on Fig. 9 on p.276 expresses the secondary energy supplied to the water heater. Secondary energy is a pure electric energy generated by a power station. However, the power generation efficiency of a power station is limited as it can only convert part of the heat generated by burning fuel into electricity. The amount of heat that was consumed at the power station is called primary energy.
- It is common to use the primary energy conversion when comparing electricity, gas, and oil. Currently, it is determined that 9,760 kJ of primary energy is required to generate 1 kWh (3,600 kJ) of electricity. In other words, a power station consumes roughly 2.7 times more energy than the amount of electricity it actually generates and supplies. For devices that use late night power, the primary energy conversion values differ according to the time of the day, that is 9,970 kJ/kWh during daytime (07:00 to 23:00) and 9,280 kJ/kWh for late-night hours (23:00 to 07:00).
- Power worth 100 secondary energy is equivalent, when converted, of roughly 270 primary energy. Based on the primary energy, then, the energy input on Fig. 9 would be approximately 270 (= 100 x 9,760/3,600). Hot water discharge obtains energy worth 305 and its efficiency would be 113% ((305/270) x 100 = 113%).
- As it is a heat-pump type that collects heat from the air, it can be said that CO₂ HP is highly efficient even based on the primary energy conversion that takes into account the loss at the power station and the power transmission line.
- On the other hand, a previously popular electric water heater uses a heater and generates heat worth 100 using secondary energy worth 100. For this reason, its efficiency based on the primary energy conversion is extremely low (Fig.). Consequently, the heat-pump type must be selected if the heat source of the device is electricity.
- Note that the heat efficiency of gas or oil water heaters generally measures only the amount of heat generated by gas or oil and does not take into account the electricity consumed by parts such as blowers, pumps, the control circuit, and the freeze protection circuit. The efficiency is also measured when discharging hot water at the maximum output (rated) and differs from the efficiency when discharging a small quantity intermittently, which often happens in actual usage.
- Note also that APF for CO₂ HP takes into consideration the temperature changes throughout the year while the heat efficiency for gas or oil is measured under constant outside air conditions.

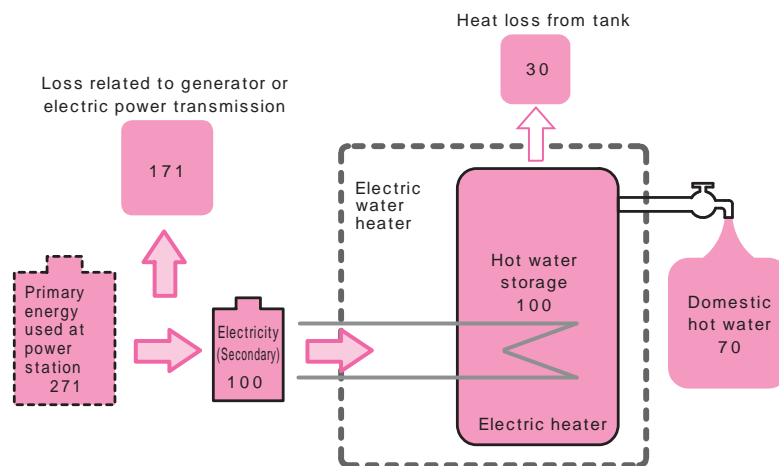

$$\text{Secondary energy efficiency} = 70 / 100 = 70\%$$

$$\text{Primary energy efficiency} = 70 / 271 = 26\%$$

Fig. Efficiency of electric water heater

5

Key Point

Efficiency indicated for Eco Cute

There are two types of efficiency values indicated in catalogs for CO₂ HP.

- In-between seasons energy consumption efficiency (In-between seasons COP)
- Annual performance factor of hot water supply (APF)

(1) Energy consumption efficiency (Heat pump unit)

- The energy consumption efficiency (COP) has traditionally been used as an efficiency value to indicate the performance of the heat pump unit alone and the amount of water heating made by the power equal to 1. On Fig. 9, the power worth 100 makes heat equal to 380 and COP is therefore 3.8. As the most common CO₂ HPs use air as a heat source, their efficiency is heavily influenced by seasonal changes in the outside air temperature. To address this issue, The Japan Refrigeration and Air Conditioning Industry Association (JRAIA) has set the following four seasonal conditions.

Table: Testing conditions for heat pump unit set by JRAIA Unit (°C)

	Outside air temperature	Temp. of water entering HP	HP discharge hot water temperature
Summer	25	24	65
In-between season (rated)	16	17	65
Winter	7	9	65
Winter using high temp. setting	7	9	Maximum temp. (Commonly 90°C)

* Winter conditions may not be included in catalogs for the energy consumption efficiency (COP) of a heat pump.

- Generally, the energy consumption efficiency indicated as rated has been measured under the in-between season conditions; however, efficiency values for the summer, winter, or winter using a high temperature setting can be obtained by dividing the heating capacity for each by the power consumption.
- Fig. a shows that the efficiency is at its highest during the summer when the outside air temperature is at its highest and decreases during the winter. The efficiency was the lowest during the winter using a high temperature setting. It is also noticeable that the efficiency of heat pumps has improved dramatically due to technological advances.
- COP value is calculated using the amount of electricity obtained by secondary energy conversion.

(2) Annual performance factor of hot water supply (APF)

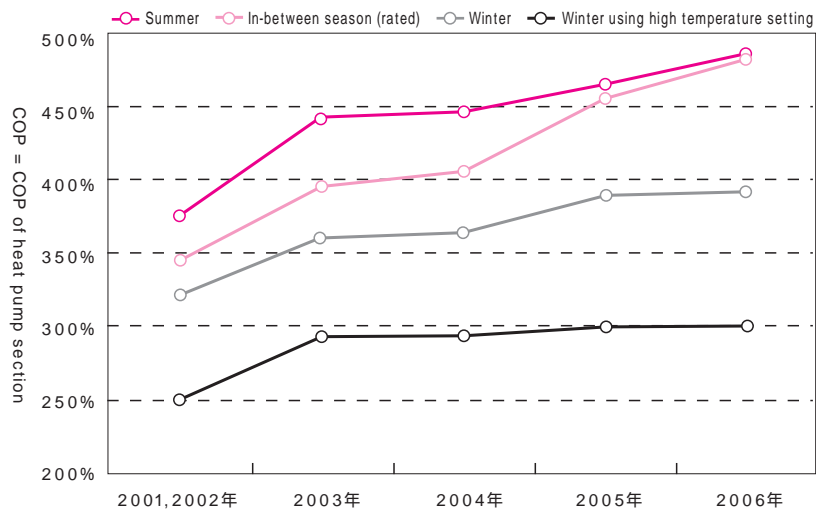

Fig. a Example of improvement in energy consumption efficiency (COP) of heat pump unit

- CO₂ HP not only comes with a heat pump unit but is also equipped with a hot water storage unit. As shown in Fig. 9 on p.276, heat loss can occur due to heat loss from the hot water storage tank. The heat loss needs to be taken into consideration here as CO₂ HP makes mostly use of late-night power and is required to store hot water for an extended period of time until the demand peaks during the evening. The heat loss can be reduced by reinforcing the insulation of the storage tank; however, the effect of this could not be evaluated using the energy consumption efficiency, which is designed to measure the performance of a heat pump alone.
- To address this issue, catalogs began indicating the annual performance factor (APF) of hot water supply. APF demonstrates the efficiency of the entire system including the hot water storage unit based on a hot-water discharge pattern mode called “IBEC L mode”.
- Another characteristic of APF is that, as is evident in its name, it takes into account changes in outside temperature throughout the year (average temperatures in Tokyo and Osaka) and indicates the efficiency for the whole year. Unlike the energy consumption efficiency, it is thus unnecessary for us to consider values according to the season when using APF.
- APF is therefore a useful index that indicates the efficiency of the entire water heater including the hot water storage unit. It is recommended that you select a CO₂ HP model with a higher APF.
- It should be noted that APF is usually based on the presumed weather conditions in Tokyo and Osaka. Generally speaking, devices would perform at a lower efficiency than their APF in colder regions and at a higher efficiency in hot humid regions. Furthermore, APF is measured based on one boiling mode (detailed explanation provided later in the chapter) and the efficiency can vary when using different boiling modes.
- APF, like COP, is calculated using the amount of power obtained from the secondary energy conversion (See p.277) and needs to be converted into primary energy when comparing with gas or oil.

* Although both COP and APF are used for the efficiency of air conditioners, they are called “space cooling and heating average energy consumption efficiency” and “annual energy consumption efficiency”, respectively. As both are devices utilizing heat pumps, the content for these indicators are mostly identical.

How to use CO₂ HP efficiently

Key Point

(1) Improving the efficiency of CO₂ HP

- One of the characteristics of CO₂ HP is that its efficiency can vary greatly depending on how it is used. Occupants therefore need to understand the correct way of using the device so as to maximize its potential.
- The key point to maximize the potential of CO₂ HP is to use up the entire hot water store for the day. In other words, it is important to store the minimum heat quantity necessary.
- Since “Stored hot water heat quantity = amount of stored hot water x (hot water storage temperature – tap water temperature)”, to minimize the stored hot water heat quantity, we can either “reduce the quantity of stored hot water” or “lower the stored hot water temperature”. If the stored hot water heat quantity is kept low, it will also reduce the wasteful heat loss from the hot water storage unit as well. Furthermore, lowering the stored hot water temperature (≈ HP hot water discharge temperature) will not only reduce heat loss but also improve the efficiency of the heat pump. With better efficiency for both the hot water storage unit and the heat pump unit, the efficiency of the device as a whole improves greatly (Fig. a).
- If the remaining hot water display on the remote control shows that there is little hot water at the end of the day, it means that the user is taking full advantage of the performance potential of CO₂ HP (Fig. b). By the same token, if the remaining hot

5

Chapter 5 Energy-efficient Equipment Technology (Elemental Technology Application Method 3)

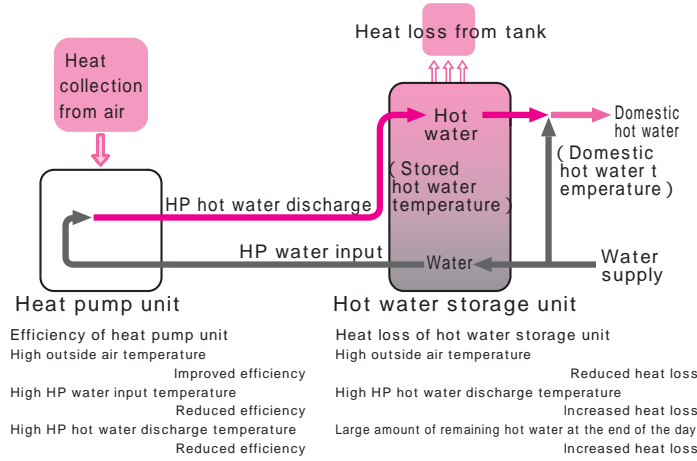

Fig. a Key points and points of caution to maximize potential of CO₂ HP

Note 1: The temperature of the hot water discharged from HP is called "HP hot water discharge temperature" while the temperature of the hot water stored in the tank is called "stored hot water temperature". Theoretically, both temperatures would be identical if it were not for the slight heat loss from the hot water storage tank. In reality, the stored hot water temperature is slightly lower.

Note 2: The temperature of the hot water can usually be set by the user via remote control. This temperature, called the "domestic hot water temperature", refers to the temperature of the hot water being discharged from the domestic hot water supply opening of CO₂ HP toward the faucet. Note that CO₂ HP mixes water with the stored hot water to supply domestic hot water and its stored hot water temperature therefore is higher than the domestic hot water temperature. Setting this domestic hot water temperature lower is an effective way to lower the HP hot water discharge temperature.

Note 3: Generally, the lower limit of the stored hot water temperature is set at 65 °C for storage water heaters to prevent the spread of Legionella bacteria.

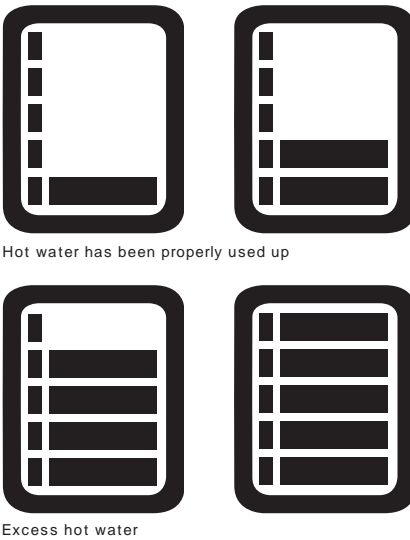

Fig. b Example of remaining hot water display
This model displays the remaining hot water level with black bars. Verify the details of the remaining hot water display with the user's manual.

water level is high at the end of the day, it means that the unit has been storing unnecessary remaining water throughout the day. This creates a situation where more loss from the hot water storage unit occurs. The stored hot water temperature also tends to be high in this situation, which leads to a reduced efficiency of the heat pump. In consequence, the efficiency of the device as a whole decreases significantly and the performance potential of CO₂ HP will not be maximized.

- Keeping the stored hot water temperature low is also very important in increasing the efficiency of the heat pump. Although, the HP hot water discharge temperature is commonly between 65 and 90 °C, it is desirable to control the temperature as close as possible to the lower limit of 65 °C throughout the year. It is also recommended to check periodically the stored hot water temperature by remote control.

(2) Setting boiling mode to "energy-efficient"

- The "boiling mode" controls elements such as the remaining hot water level and the stored hot water temperature. This mode can easily be changed using the CO₂ HP's remote control (See the device's instruction manual for details on settings).
- There are several boiling modes available on any models; however, the "energy-efficient mode" can significantly increase the efficiency of the device by learning the hot water consumption patterns of the household and adapting the remaining hot water level and stored hot water temperature accordingly.
- The actual name of the "energy-efficient" mode can vary from model to model (Table p.281). This "energy-efficient" mode is strongly recommended for households with a normal level of hot water consumption, as it is superior in both energy-saving and economic aspects. Fig. c shows the primary energy consumption by boiling mode.
- The initial setting of many CO₂ HPs in the past was not the energy-efficient mode. It is therefore recommended that users check the setting of their CO₂ HPs already installed. Almost all CO₂ HPs being shipped now are expected to be set at the energy-efficient mode as their initial setting and should be used as is for energy-saving purposes.
- Note that this document will present the energy performance of CO₂ HPs set at "energy-efficient" mode. However, these results were obtained by using the "energy-efficient" mode whereby the remaining hot water level was kept low throughout the year and the stored hot water temperature was maintained very near the lower limit of 65 °C. In other words, the same results cannot be expected even when using the "energy-efficient" mode, if the remaining hot water level is high or the stored hot water temperature is considerably higher than 65 °C.

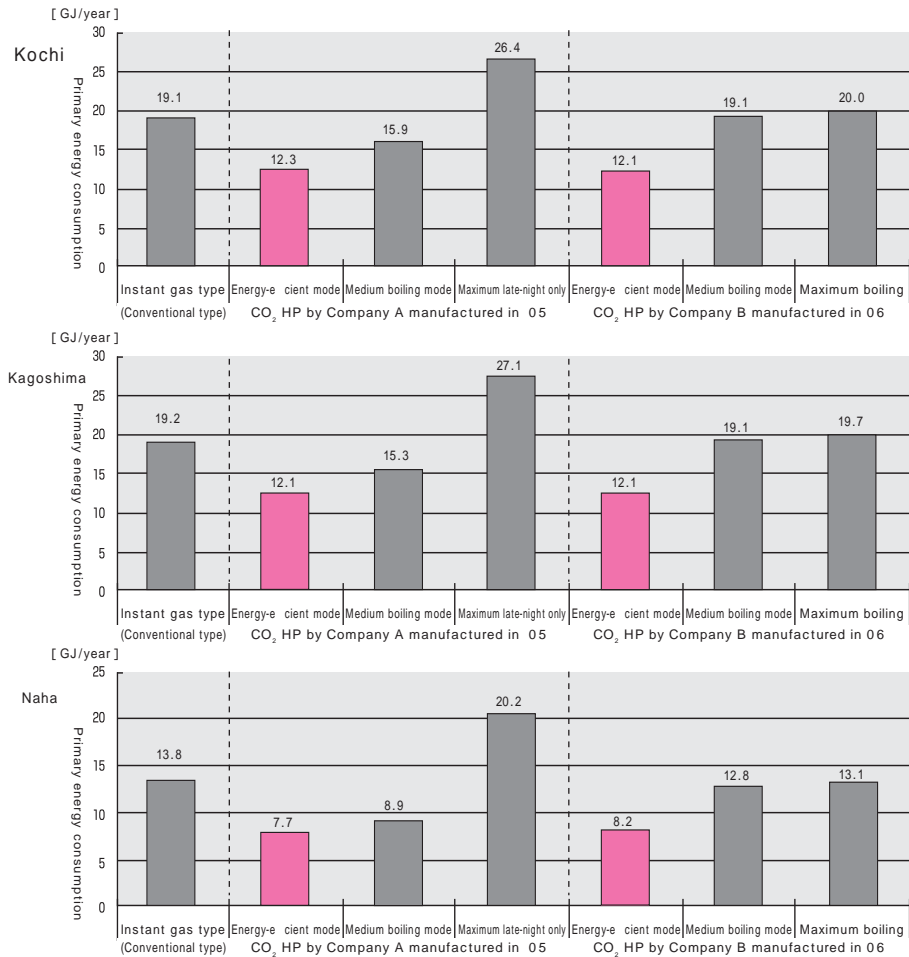

Fig. c
Changes in annual primary energy consumption using CO₂ HP at various modes

Table: Types and characteristics of boiling modes

Type	Example of mode name	Characteristics
Energy-efficient mode (automatic learning control)	“Auto (low)”, “Saving”, “Low boiling”, “Auto level 1”, “Auto low”, “Recommended”, etc.	<ul style="list-style-type: none"> Automatically learns from the past hot water consumption history and controls the remaining hot water level appropriately according to the household to maintain the remaining hot water at a low level. Controls to keep the stored hot water temperature as close as possible to the lower limit (65°C). Rarely runs out of hot water since it automatically starts additional daytime boiling when the remaining hot water falls below the set level. Generally best in energy-efficiency and economy due to its low heat loss from the tank and the high HP efficiency. Strongly recommended.
Medium boiling (automatic learning control)	“Auto (medium)”, “Auto”, etc.	<ul style="list-style-type: none"> Based on the past hot water consumption history, maintains the remaining hot water level at medium. Slightly higher stored hot water temperature. Boiling during the day when necessary. Compared to “energy-efficient” mode, the heat loss from the tank is increased. Lower HP efficiency.
Maximum boiling (automatic learning control)	“Auto (high)”, “Plenty”	<ul style="list-style-type: none"> Based on the past hot water consumption history, maintains the remaining hot water level higher than strictly necessary. The stored hot water temperature almost reaches the maximum allowed (90°C). Extremely high heat loss from the tank. Significantly lower HP efficiency. Lowest in overall efficiency. Performs frequent additional boiling when the remaining hot water level decreases. This increases the percentage of power used during the day, making it costly.
Medium late-night only (usually not equipped with automatic learning control)	“Late-night only, medium hot water level”, “Late-night only”, etc.	<ul style="list-style-type: none"> Performs boiling only during the late-night power period. Often fills up the hot water storage tank during the late-night power period. Slightly higher stored hot water temperature. inconvenient as the user must manually start the additional boiling if it runs out of remaining hot water. Increased heat loss from the tank. Reduced HP efficiency. Since efficiency is lower than the energy-efficiency mode, generally offers no economic advantages.
Maximum late-night only (usually not equipped with automatic learning control)	“Late-night only, high hot water level”, etc.	<ul style="list-style-type: none"> As with “medium late-night only”, performs boiling only during the late-night power period. Often fills up the hot water storage tank during the late-night power period. The stored hot water temperature almost reaches the maximum allowed (90°C). HP efficiency is greatly reduced as HP discharges hot water at the maximum temperature. Extremely high heat loss as it fills up the hot water storage tank during the late-night period. Very low overall efficiency. Not recommended.

5

Chapter 5 Energy-efficient Equipment Technology (Elemental Technology Application Method 3)



Fig. b Detailed display of remaining hot water level

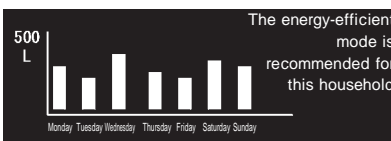

Fig. e Display of hot water consumption history

(3) Understanding characteristics of boiling mode

- There may be concern about running out of hot water with the “energy-efficient” mode since it maintains the remaining hot water at a low level; however, the actual risk of running out of hot water is minimal since it is programmed to automatically perform boiling when the level of the stored hot water falls below the lowest limit at times other than late-night, even during the day (daytime boiling).
- As electricity is more expensive during the day compared to late-night, some people set the device to “late-night only” mode that does not perform boiling during the day to be economical.
- However, the “late-night only” mode tends to boil more water than strictly necessary and, if the hot water usage is low, causes the efficiency to decrease due to an excess in the remaining hot water and an increased amount of heat loss. When this happens, from the economical point of view, the “late-night” mode is not more advantageous than the “energy-efficient” mode. Furthermore, when the device is not allowed to perform any daytime boiling, the user must set the boiling manually with a remote control when the remaining hot water level becomes low, which is rather inconvenient.
- Some models offer remote controls capable of displaying the remaining hot water level in more detail (Fig. d).
- When more hot water is required than usual, such as when having over-night guests, you can ensure that more hot water is available by performing a forced boiling.
- If the remote control frequently indicates that the remaining hot water level is low when using the “energy-efficient” mode, another mode needs to be selected to increase the remaining hot water level; however, do not immediately select the “maximum boiling mode” but rather increase the level slightly each time. It is also strongly recommended that effort be made to reduce hot water consumption as well.

(4) Useful tips on hot water consumption

- Some boiling modes such as the “energy-efficient” mode learn the hot water consumption patterns of the household (Fig. e); however, these modes tend to control the remaining hot water level according to days with higher hot water consumption to avoid running out of hot water.
- If the hot water consumption of the household fluctuates greatly from day to day, the efficiency of the device will be reduced on days with lower hot water consumption due to excessive remaining hot water caused by the device maintaining a higher remaining hot water level. Evening out the daily hot water consumption (preferably toward the lower end of the spectrum) increases the efficiency as well as the accuracy of the control of remaining hot water. Being mindful of hot water use is also important when using a CO₂ HP.
- Some models offer remote controls capable of displaying recent hot water consumption history. Understanding the household’s hot water consumption by using functions such as this should facilitate even greater energy efficiency.
- Furthermore, it is best to avoid using a circulation reheating function since the efficiency of many water heaters including CO₂ HPs decreases when one is used. Some devices’ initial setting may include the automatic “keep-warm” function after filling. It is recommended that the user change the setting to avoid using this function frequently.
- The use of the “hot water adding” function is recommended when the bathwater has cooled down; however, if a large amount of hot water is required to increase the temperature of the bathwater, small efforts such as getting rid of some of the cooled bathwater beforehand might prove beneficial.
- Some models of CO₂ HP do not allow circulation reheating and can only perform the “hot water adding” function when set at the “energy-efficient” mode.

1. Considerations for domestic hot water piping system

1) Hot water saving piping construction

- Two types of domestic hot water piping systems are available: the conventional branched piping system and the header-conduit piping with sleeve tube (Fig. 11).
- Adopting the header-conduit piping with sleeve tube allows you to reduce the diameter of the pipe that normally goes from the tip of the header to the system device installed in the house. This will in turn reduce the amount of wasted hot water compared to the branched piping system. As a result, the efficiency can be expected to improve by approximately 5%; however, note that the initial cost is expected to be higher than that of the branched piping system.

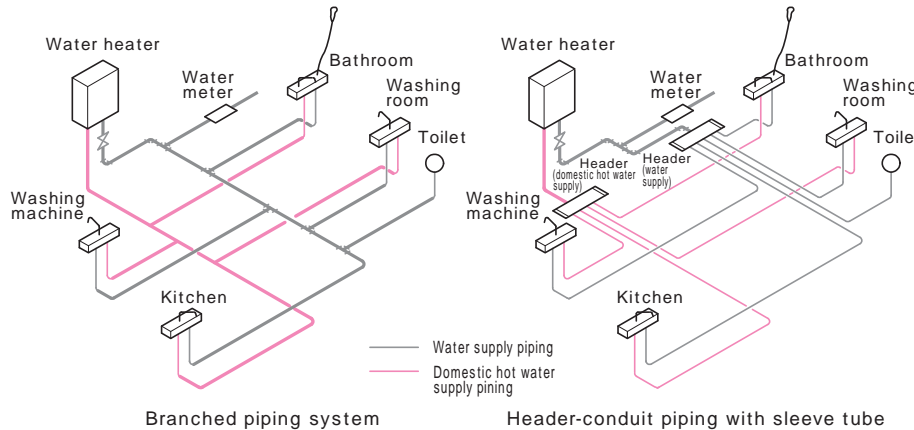

Fig. 11 Types of domestic hot water piping system

2) Minimizing pipe diameter and shortening length of domestic hot water piping route

- Even after the faucet has been turned off, some hot water still remains in the domestic hot water supply pipe. Reducing the amount of wasted hot water that remains in the piping, by either shortening the length of the domestic hot water piping route or reducing the diameter of the pipes, can be a way to save hot water. This will also reduce the amount of heat required to heat the piping as well as the heat loss from the piping and increase the efficiency of domestic hot water supply. Furthermore, it will shorten the wait-time for hot water and improve the amenity factor.
- Above-mentioned measures also apply to the header-conduit piping with sleeve tube.

3) Thermal insulation of domestic hot water piping

- Thermal insulation of domestic hot water piping is an important factor when using a circulation-type domestic hot water piping system such as reheating, automatic “keep-warm” or floor heating. (See “Key Point: Heat loss by heat source equipment and underfloor and piping insulation” of Section 5.2 Heating and Cooling System Planning on p.238 for more detail of thermal insulation of piping.)

4) Considerations for placement of water heater

- If the water heater is not placed in an appropriate space, the piping for domestic hot water supply as well as that for the bathtub may need to be longer, which may reduce the energy-saving effect and create inconvenience by making the wait-time longer for the hot water.
- The placement of the water heater needs to be carefully considered beforehand so as to make the piping route as short as possible between the water heater and various domestic hot water supply points.
- The hot water storage type such as the solar water heater and CO2 HP require an especially large set-up space, which may limit the choices of its placement. It is best to take this fact into consideration right from the initial stages of residential designing.

5

5) Thermal insulation of bathtub and bathroom

- Taking a bath, which is very common in Japan, consumes much energy as it requires not only the filling of the bathtub with hot water, but also the keeping of the water at a warm temperature, or its reheating when it cools down. Furthermore, keeping the water warm or reheating it decreases the efficiency of the water heater. Efforts therefore should be made to not have the hot water cool down in the first place.
- Insulating the bathtub is an effective way of preventing the hot water in the bathtub from cooling down. In recent years, we are seeing some with insulation material such as urethane sprayed on and others wrapped in double-layer insulation material to increase the thermal insulating performance (Fig. 12).
- The Eco Mark certification standards for bathtubs with high thermal insulation performance (No. 139 “Bath Unit for Dwellings”) are now in place and expected to be commercially available in the near future (Fig. 13). The bathtub must demonstrate a high level of thermal insulation performance by keeping the loss in temperature of the hot water to less than 2°C during a four-hour period even in winter; however, it is essential to deploy a highly-insulated bathtub lid to maintain the temperature as the heat loss is greatest on the surface of the bathwater.
- It is also important to improve the thermal insulation performance of the bathroom as a whole. This will not only reduce the energy consumption related to bathing but also improve the comfort and the healthfulness of the space in the bathroom and other related rooms. Selecting an appropriate thickness of insulation material can also be an important issue as we are seeing whole bathroom units wrapped in insulation material in recent years (Fig. 14).



Fig. 12 Example of thermal insulation of bathtub



Fig. 13 Eco Mark ちきゅうにやさしい = Gentle on the Earth

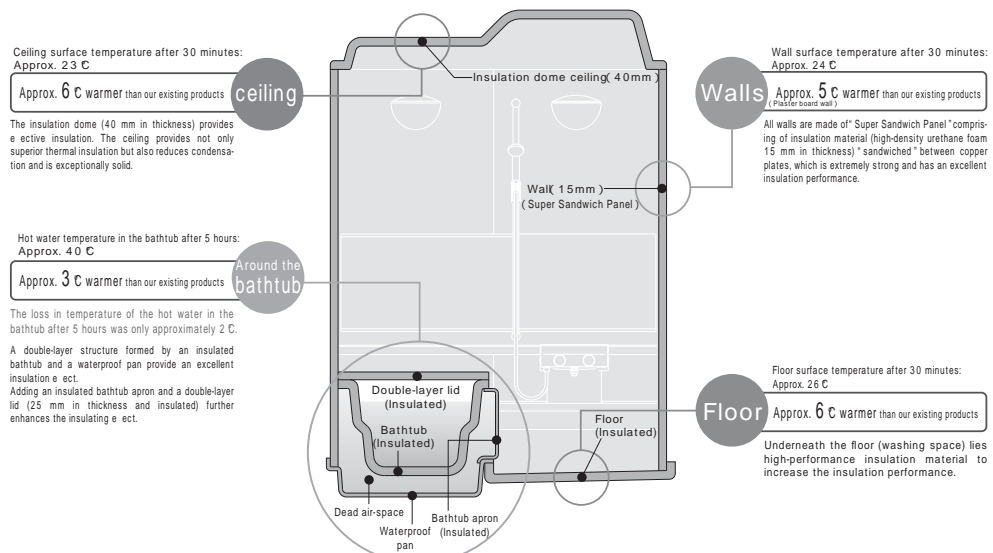

Fig. 14 Bathroom unit with high thermal insulation performance

Key Point

Bathing in energy-efficient manner

As bathing in the bathtub consumes the most energy in all domestic hot water, it is necessary to be mindful of energy-efficiency when doing so. As mentioned previously, thermal insulation of the bathtub (including the lid) as well as the bathroom is effective; however, the following key points should also be considered in order to realize better energy-efficiency.

(1) Water heater settings and tips on how to use it

- Today's common water heaters are equipped with a "keep-warm" function. This function automatically keeps the cooling bathwater warm when it detects that the bathwater temperature is low during the set "keep-warm" period. While convenient, this function can consume a large amount of energy when used frequently and reduces the efficiency of the water heater. It is therefore recommended to avoid using this function when possible to achieve better energy-efficiency.
- If using the "keep-warm" function, the following points should serve as important reminders.
 - a. The initial setting for the "keep-warm" period may be as long as four hours. This can lead to the hot water temperature being unnecessarily maintained. Verify the setting for the "keep-warm" period and set it as short as possible.
 - b. The last person to bathe must make sure to turn off the "keep-warm" function. Similarly, the function must be turned off when the bathtub is emptied. If the function is turned on after the bathtub is emptied, the water heater will attempt to maintain the water level and consume water unnecessarily.
- It is best to use an "adding" function instead, which adds high-temperature water from the faucet. As today's water heaters are most efficient when supplying hot water rather than maintaining temperature or reheating, the "adding" function is the most energy-efficient.

(2) Tips on how to bathe

- People have always been trying to devise ways to save water when bathing and some can still be relevant and effective today.
 - a. Take a bath as soon as possible after filling up the bathtub.
 - b. Organize the bathing time of the whole family within a short period of time so as to save energy required to keep the water warm. If that is not possible, make sure to turn off the "keep-warm" function of the water heater.
- In the past, people frequently reheated the remaining bathwater of the day before. While re-boiling of the remaining water (reheating) certainly saves water, is not necessarily energy-efficient as the bathwater would be completely cold unless in a high-performance insulated bathtub. Using the reheating function also reduces the efficiency of the water heater. It is not a recommended function to use especially with CO₂ HP, which tends to lack the capacity to reheat remaining water and the efficiency of which is heavily and negatively influenced by it. Furthermore, remaining water may contain bacteria, etc., and can be problematic health-wise. For these reasons, reheating remaining water may not necessarily be recommendable.

5

2. Considering hot water saving devices

- The energy saving effect can be improved upon by adopting hot water saving devices and not running the tap unnecessarily.
- Saving the amount of domestic hot water not only leads to energy-efficiency but also saving water resources.

1) Easy temperature adjustment of hot water with cold and hot water mixer faucet

- With a conventional faucet, there is much wasted water when adjusting the temperature every time domestic hot water is used or having to readjust due to other faucets being used. Thermostatic mixer faucets and single lever mixer faucets allow for an easy temperature adjustment of the domestic hot water and reduce wasted water when adjusting the temperature. It is recommended that these two be used instead of two -valve mixer faucets (Fig. 16).
- Water saving plumbing parts can also serve as another means to control the quantity of hot water.

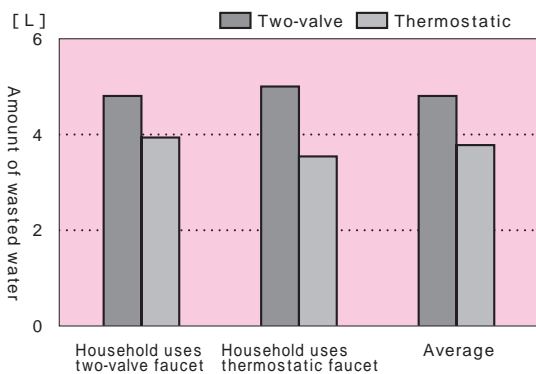

Fig. 15 Comparison of wasted water of mixer faucets



Fig. 16 Examples of hardware for domestic cold and hot water supply faucets

2) Various devices with shut-off valves

- In the bathroom, it is effective to use a hand-held hot water saving shower head equipped with a shut-off mechanism (Fig. 17 and Fig. 18).
- It is recommended to use a shower faucet in the kitchen and the washing room and to install a foot-controlled water shut off (Fig. 19) or an automatic faucet.

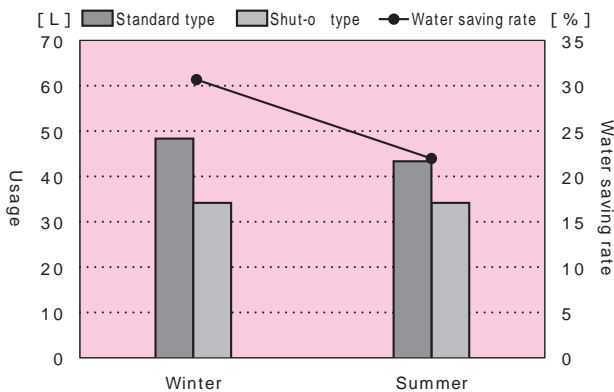

Fig. 17 Comparison of cold/hot water usage by type of showerhead

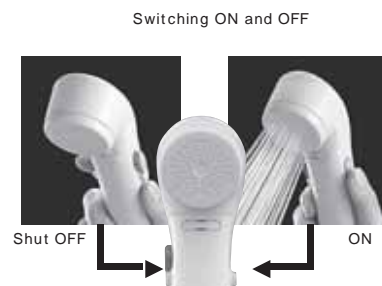

Fig. 18 Example of shower-head with shut-off mechanism



Fig. 19 Example of foot-controlled water shut off

Key Point

Single lever faucets

- It is now common to use single lever faucets in kitchens and washing rooms. While this type of faucet is very convenient, incorrect use can result in increased hot water consumption.
- Many people use their single lever faucets with the lever positioned in the middle. This means roughly an equal amount of domestic hot and cold water are mixed. Only when the lever is positioned to the extreme right will you get cold water alone (Fig.).
- It is probable that many people use domestic hot water mixed with cold water unintentionally even during the summer or in-between seasons when the water temperature is sufficiently high and mixing in hot water is not necessary.
- Furthermore, when water is used for a very short period of time, such as washing hands in the washing room, the faucet is turned on and off before the domestic hot water from the water heater reaches the faucet. When this happens, the hot water will cool down in the pipe and is completely wasted.
- Also, this type of short-period hot water discharge reduces significantly the efficiency of the water heater and leads to energy loss. This is especially true for instant gas or oil water heaters wherein the burner burns only for a short time.
- Single lever faucets therefore should normally be used at the “cold water only” position and the user should only move the lever to add hot water when necessary.

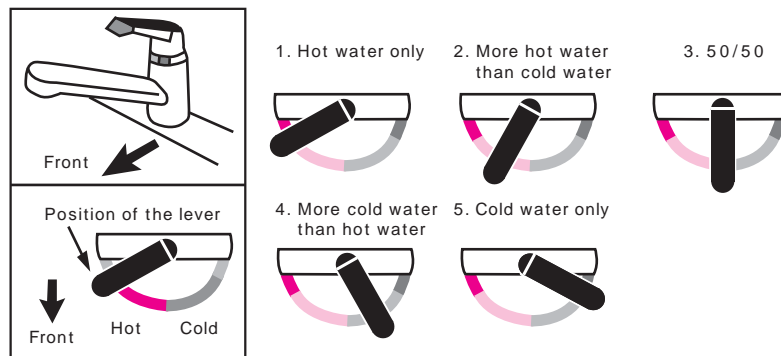

Fig. Operating lever of single lever faucet

5

Chapter 5
Energy-efficient
Equipment Technology
(Elemental Technology
Application Method 3)

5.5 Lighting System Planning



The purpose of lighting system planning is to supplement the lack of illuminance during the day when daylight utilization is not sufficient and maintain a good light environment during nighttime. Furthermore, a lighting system makes use of technologies aimed at reducing lighting energy consumption.

Its ultimate goal, it can be said, is to realize energy efficiency while maintaining and enhancing comfort. That being said, the way the light is perceived can vary from one individual to another depending not only on factors such as age and eyesight, but also on how people's eyes adapt to the level of darkness or brightness. Careful consideration is therefore required when planning a lighting system, as it is also relevant to the safety of the living space.

5.5.1 Purpose and Key Points of Lighting System Planning

- Lighting system planning makes use of technologies aimed at supplementing the lack of illuminance during the day when daylight utilization is not sufficient, creating an appropriate light environment suitable for the nighttime activities of each space, and reducing lighting energy consumption.
- The lighting system planning can offer a better energy saving effect as it combines the use of daylight utilization technologies (See Section 3.2 Daylight Utilization on p.066) such as the daylighting method and the daylight guiding method.
- There are three methods required to complete the energy saving method of the lighting system planning: the “method using device”, which makes use of energy-efficient lighting devices to reduce energy consumption; the “method using operation and control”, which makes use of various tools of control such as ON/OFF and dimming to provide the appropriate lighting for the appropriate time (providing an appropriate amount of lighting for an appropriate length of time); and the “method using design”, with which one prepares an appropriate layout plan for lighting devices to provide the appropriate lighting for the appropriate place (providing an appropriate amount of lighting at an appropriate location).
- Fig. 1 shows the overview of the energy-efficient technologies of the lighting system planning. The underlying principle is to move from a one-light-per-room lighting system to a distributed multiple lighting system.

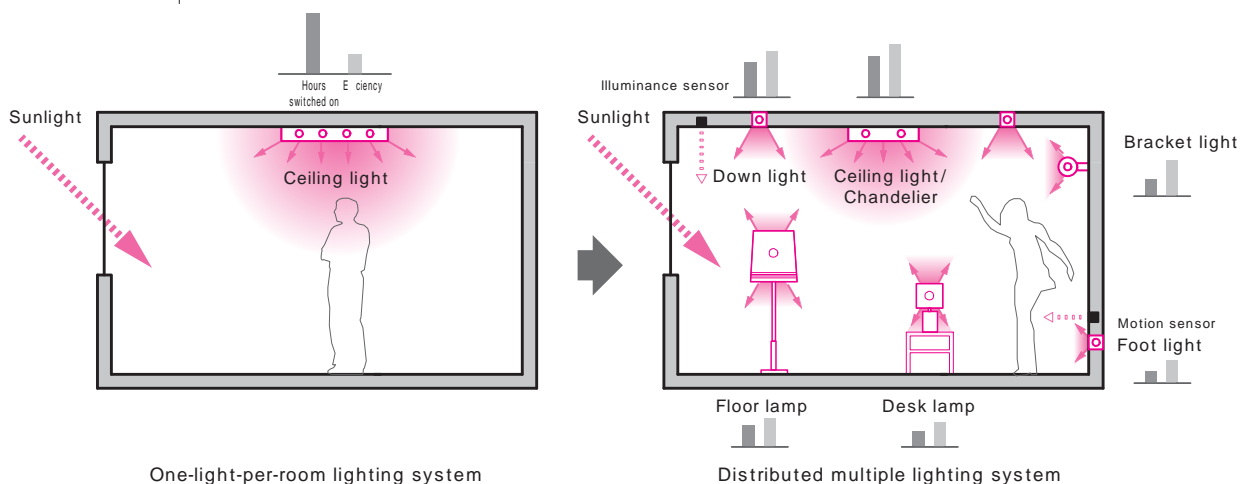

Fig. 1 Overview of energy-efficient technologies for lighting system planning

5.5.2 Energy Conservation Target Levels for Lighting System Planning

1. Definition of target levels

- As shown below, energy conservation target levels 1 to 3 for the lighting system planning are defined according to the lighting energy reduction rate of the entire household. Note that the reduction rate varies between Zone VI and Zone V.

	Zone VI	Zone V
Level 0 : Lighting reduction	0	0
Level 1 : Lighting reduction rate	Approx. 15%	Approx. 30%
Level 2 : Lighting reduction rate	Approx. 20%	Approx. 40%
Level 3 : Lighting reduction rate	Approx. 30%	Approx. 50%

- The typical lighting energy consumption in 2000 was 13.6 GJ (roughly 20% of the entire energy consumption) for Zone VI and 11.3 GJ (roughly 17%) for Zone V (See Section 6.1 on p.339).
- Any level mentioned above can be achieved by combining the “method using device”, the “method using operation and control”, and the “method using design”.

2. How to achieve target levels

- Table 1 shows guidelines for matching each energy conservation target level with the corresponding method to be applied.
- Level 0, which serves as the basis of the evaluation, employs the conventional one-light-per-room lighting system. This lighting system refers to the conventional lighting method that places one lighting device using an incandescent bulb or a common florescent bulb near or at the center of the ceiling.

Table 1 Target levels for lighting system planning and how to achieve them

Target level	Energy saving effect (lighting energy reduction rate)		Applied methods
	Zone VI	Zone V	
Level 0	0	0	Conventional methods
Level 1	Approx. 15%	Approx. 30%	Method 1: Method using device
Level 2	Approx. 20%	Approx. 40%	Method 1: Method using device Method 2: Method using operation/control
Level 3	Approx. 30%	Approx. 50%	Method 1: Method using device Method 2: Method using operation/control Method 3: Method using design

- Level 1 can be achieved by making use of energy efficient devices such as energy-efficient lamps (Method 1: Method using device).
- Level 2 can be achieved by implementing Level 1 and adding the energy saving effect of frequent control of on/off time of lighting devices (Method 2: Method using operation and control).
- Level 3 can be achieved by implementing Level 1 and Level 2, and placing multiple lighting devices at various locations (distributed multiple lighting system) in rooms used for multiple purposes such as the living room. This will allow the occupants to set an appropriate light environment by, for example, choosing lighting patterns (selecting which light to turn on or off).
- The change in reduction rate between Level 0 and Level 1 as well as Level 1 and Level 2 differs in Zone VI and Zone V. This is due to the fact that the model plan for Zone VI (See p.344-345) uses much incandescent lighting and its area of non-habitable rooms (not used for an extended period of time), where many devices with control are found, was smaller than that of the model plan for Zone V (See p.346-349). Its reduction rates therefore were also lower. On the other hand, the change in reduction rate between Level 2 and Level 3 is the same for both zones (simulated a simple distributed multiple lighting system). The reduction rate can be further improved by planning a full-fledged distributed multiple lighting system in Zone VI as the living room area there is larger than in Zone V.

Points of Caution
To achieve Level 3, along with the design of the system, the occupants must be made aware of the correct way of using it.

5

Chapter 5
Energy-efficient Equipment
Technology
(Elemental Technology
Application Method 3)

5.5.3 Steps for Considering Lighting System Planning

- Consider the light environment required for each space. When doing so, bear in mind that the occupants' age and eyesight need to be taken into account as well.
- Thoroughly determine the sunlight condition of each space during daytime and examine spaces where the light environment needs to be improved.
- Select the placement of lighting system as well as its light sources and types of devices for each space. When doing so, ensure to take into account how an individual would adapt to the dark or the light when moving from one space to another.
- Consider the method of control and the position of the switch for each lighting device.

Step 1 Considering light environment required for each space

- 1) Consider the activities that take place in each space.
- 2) Confirm the eyesight of the occupants using each space.

Step 2 Considering locations where daylight is lacking

- 1) Understand thoroughly the sunlight condition and plan daylight utilization.
- 2) List locations where daylight is insufficient and how much.

Step 3 Considering placement of lighting, light source and types of devices for each space

- 1) Consider the placement of lighting and the illuminance for each space (Method 3).
- 2) Select a light source as well as types of devices that offer superior energy saving effect (Method 1).
- 3) Consider the coordination between the interior design and the devices.
- 4) Verify the difference in illuminance when moving from one space to another.

Step 4 Considering method of control and placement of switch for each lighting device (Method 2)

- 1) Consider the method of control of each lighting device.
- 2) Consider the placement of the switch.

5.5.4 Energy Saving Methods in Lighting System Planning

As previously discussed, to reduce lighting energy consumption, three methods—the method using device, the method using operation and control, and the method using design—must be combined appropriately during the planning phase. To realize this, the following steps are to be followed when designing. Note that a detailed explanation on each method will be provided later in this chapter.

1) Verify activities conducted in space

It is necessary to examine the activities that take place in each space of a house on an hourly basis so as to determine the required light environment.

2) Verify basic required illuminance

Determine the required illuminance (lx) for each activity to take place in each space. Refer to Fig. 2 that shows the Japanese Industrial Standards “Recommended Levels of Illumination”.

Fig. 2 Recommended levels of illumination for houses (JIS Z 9110)

Illuminance lx	Living room	Den	Children's room/Study	Parlor (Western-style)	Parlor (Japanese-style)	Dining room/ Kitchen	Bedroom	House work room/Workroom	Bathroom/ Changing room	Toilet	Hallway/ Stairs	Closet/ Storage	Entrance (inside)	Gate/Entrance (outside)	Garage	Yard
2,000	-	-	-	-	-	-	-	-	-	-	-	-	-	-	-	-
1,500	Crafts Sewing	-	-	-	-	-	-	Crafts Sewing Sewing machine	-	-	-	-	-	-	-	-
1,000	-	-	-	-	-	-	-	-	-	-	-	-	-	-	-	-
750	Reading Make-up ¹⁰ Phone call ¹⁴	Study Reading	Study Reading	-	-	-	Reading 化粧	Machine work	-	-	-	-	Mirror	-	-	-
500	-	-	-	-	-	Dining table Kitchen counter Kitchen sink	-	-	Shaving ¹⁰ Make-up ¹⁰ Washing	-	-	-	Entrance shoe-rack Cabinet	-	Cleaning Inspection	-
300	Family time Entertainment ¹¹	-	Playtime	Table ¹² Sofa Cabinet	Table (Japanese-style) ¹² Alcove	-	-	Laundry	-	-	-	-	-	-	-	-
200	-	-	-	-	-	-	-	-	-	-	-	-	-	-	-	-
150	-	-	General	-	-	-	-	-	-	-	-	-	-	-	-	-
100	-	General	-	-	-	-	-	General	General	-	-	-	General	-	-	Party Meals
75	-	-	-	-	-	-	-	-	-	-	-	-	-	-	-	-
50	General	-	-	General	General	-	-	-	-	-	-	-	-	Gate/Name plate Letterbox Doorbell	General	Terrace General
30	-	-	-	-	-	-	-	-	-	-	-	-	-	-	-	-
20	-	-	-	-	-	-	General	-	-	-	-	-	-	-	-	-
10	-	-	-	-	-	-	-	-	-	-	-	-	-	-	-	-
5	-	-	-	-	-	-	-	-	-	-	-	-	-	Pathway	-	Pathway
2	-	-	-	-	-	-	-	-	-	-	-	-	-	-	-	-
1	-	-	-	-	-	-	Late night	-	-	Late night	Late night	-	Security	-	-	Security

10. Illuminance here mainly refers to the vertical illuminance on individuals.

12. The purpose here is to create local lighting locations where it is several times brighter than the general lighting so as to create differences in illuminance within the room and to avoid flat overall lighting.

13. Light reading is included in “Entertainment”.

14. Applies to other locations as well.

Remark 1: It is preferable to make use of both general lighting and local lighting according to the purpose of the space.

Remark 2: It is preferable to install a dimmer to allow for lighting adjustment in the living room, the parlor, and the bedrooms.

The illuminance values serve as a guide and a strict adherence to them is not required. It is ideal to perform illuminance calculations and prepare an illuminance distribution diagram to examine the distribution of light; however, it is not necessary to be as strict when planning a system for home use. This is due to the fact that the proper amount of light in a house can vary greatly depending on the occupants' lifestyle and personal preferences. It is therefore important to discuss the matter with the occupants when determining the amount of light required.

The amount of light can be roughly determined simply by using the labels indicating the effective lighting area in number of *tatami* mats found on lighting devices that most light manufacturers use in their catalogs. For example, an inverter-type ceiling light using a fluorescent bulb is approximately 10 W per mat and provides approximately 100 lx to the floor surface. Even when using the distributed multiple lighting method, there should not be a problem as long as the total wattage of all the planned lighting devices is (10 W x number of mats). When doing so, bear in mind that it is assumed that incandescent light bulbs are being replaced by compact fluorescent lamps. The wattage therefore is divided by four when calculating. Furthermore, local lighting such as a small desk lamp is not to be included in the cal-

5

ulation. Note that the bedrooms would require roughly half of the above-mentioned illuminance as the calculation is based on rooms such as children’s rooms or living rooms.

The shape of the devices and the interior finish also need to be taken into consideration since, if the bulbs of the lighting devices are exposed, they will be roughly 10 to 30% brighter than if they were covered and the reflectance of the interior finish will also enhance the illuminance.

The total wattage can often exceed the recommended value when an emphasis is placed on the atmosphere of the space or many lighting devices are placed to create various moods. To ensure good energy performance, however, it is recommended that you plan the lighting devices carefully and make concerted effort to not exceed the recommended wattage by more than 20%.

Key Point

Example of lighting device wattage calculation using distributed multiple lighting system

Recommended wattage: For 13 m² (8 *tatami* mats) = 10 W x 8 = 80 W

	When all are on	When some are on
Device 1: Four down lights with 13 W compact fluorescent bulbs	13 x 4 = 52 W	13 x 2 = 26 W
Device 2: Two bracket lights with 8 W compact fluorescent bulbs	8 x 2 = 16 W	8 x 1 = 8 W
Device 3: One floor lamp with 13 W compact fluorescent bulb	13 x 1 = 13 W	13 x 1 = 13 W
Total	81 W	47 W

Pay careful attention to the balance of brightness when local lighting is required in areas such as desktops. Adopting a down light to concentrate light from above or making use of auxiliary lighting such as a desk lamp can be helpful. To verify the direct downward illuminance of a device such as a down light, refer to the direct horizontal illuminance diagrams (relational diagram depicting the height of a device and its horizontal illuminance) shown in the manufacturer’s catalog.

Key Point

Example of direct horizontal illuminance diagram of down light

- The diagram shows the relationship between the height of the down lighting device and the horizontal illuminance as well as the degree of the angle at which the light spreads.
- For example, if the height of the device is 2.0 m, the illuminance directly beneath the device is approximately 50 lx.
- The phrase “the angle at which the light spreads” refers to an angle where the brightness is half of what is directly beneath the device (half-beam angle). It may also refer to an angle where the illuminance is half of the direct illuminance, also known as half-illuminance angle.

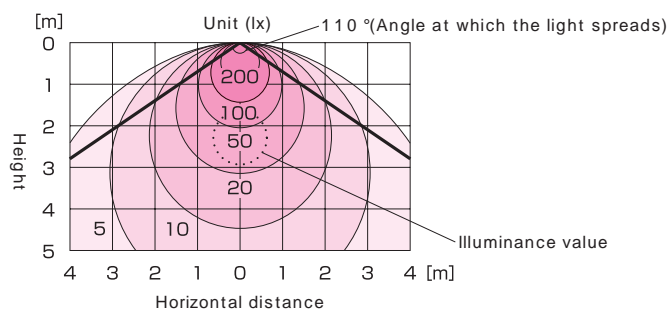

Fig. Example of direct horizontal illuminance diagram for down light

3) Correcting required illuminance according to changes in occupants

As eyesight often worsens with age, it may be necessary to correct the required illuminance for certain activities based on your understanding of the current occupants' condition and changes in the foreseeable future. It is therefore important to allow for some leeway with the required illuminance values.

Generally speaking, for seniors, it is desirable to add 50% or more to the Japanese Industrial Standards "Recommended Levels of Illumination".

4) Verifying the range and the amount of daylight utilization

Verify the areas and the amount of daylight utilization and determine the areas where artificial lighting is required to supplement the lack of daylight.

5) Planning lighting placement and selecting devices

Estimate which action may take place in which space and determine the placement of lighting to give the required illuminance. If it is highly likely that the actions taking place in the space will change due to occupants' moving furniture or other reasons, rather than depending heavily on positions of the furniture placement, plan the lighting by dividing the room into areas where light is needed and areas where it is not. Pay attention to the harmony between the lighting and elements such as the form of the room and the interior finish as well. If the space allows, adopting mobile lighting such as lamps is also effective.

When building a light environment, it is necessary to consider not only the functional lighting appropriate for actions but also the atmosphere that the light creates. For example, by brightening up the wall surfaces, the atmosphere of the room as a whole can be made brighter while the space will have a calmer feel with low lighting. The same devices placed in multiple locations will give a rhythm to the space while placing a chandelier will create a glamorous feel. When using indirect lighting, it can be effective to take into account the reflectance of the interior finish (See Section 3.2 Daylight Utilization on p.082).

Light colors are also an important element of light. Using different light colors to suit the purpose of the space is effective in creating an atmosphere. For example, white light creates a lively space while warm-colored light gives the room a calmer feel. Children's rooms therefore should have mostly white lighting and bedrooms, warm-colored lighting.

Furthermore, consider whether maintenance work such as cleaning and changing light bulbs can be done with ease. Also, select light bulbs that the occupants can easily obtain. If the lighting is for supplementing daytime utilization, ensure that the plan does not waste energy by carefully verifying the areas and the amount of light required.

6) Considering methods of control

Consider methods of control in order to create a lighting pattern appropriate for each action. If the area requires detailed lighting settings, use a device that allows dimming control. If not, an energy efficient device should be used for on/off controlled lighting. It is also effective to employ a motion sensor in areas which people use infrequently or an illuminance sensor where daylight utilization is expected. Consider also coordinating such elements with systems other than lighting such as a security system.

Also pay attention to the flow line and install switches where they can be easily reached. Install three- or four-way switches for locations such as stairs and hallways.

7) Verifying safety

Pay close attention to the safety of pathways where stairs or steps are present. Ensure that enough light is provided by referring to the Japanese Industrial Standards "Recommended Levels of Illumination". Various points of view need to be simulated as, even when lighting is available, one's feet can be in the shadow depending on the position. Do not neglect ensuring the safety of senior occupants.

It can often be difficult to see when one is moving from a brightly lit space to a dark one even when enough illuminance is provided. It is therefore crucial to ensure that there are no obstacles such as steps on the flow line.

5

Method 1: Method using device

Depending on the types of lighting system devices installed, it is possible to provide the same brightness with less energy or a brighter space and a better light environment with the same amount of energy. Characteristics and energy saving methods vary from one device to another. From the point of view of energy efficiency, it is desirable to select a device with lower energy consumption even if the initial cost is slightly higher. If the running cost is taken into consideration, the total cost often ends up being less in the end (Fig. 3). Be sure to collect relevant information regarding all devices and make an appropriate selection.

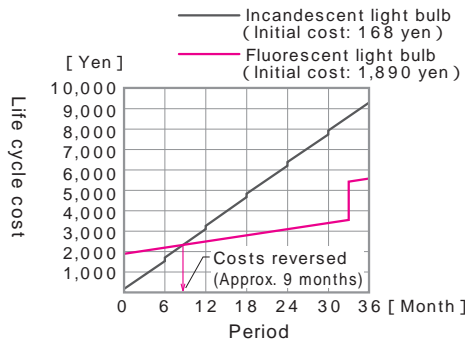

Fig. 3 Example of cost test calculation for incandescent light bulb and fluorescent light bulb
Source: *Lab Report for Everyday Life*, Tokyo Electric Power Company

Trial conditions
Hours switched on: 6 hours per day
Incandescent light bulb: Power consumption = 54 W; approx. power cost per hour = 1.2 yen; changed twice a year
Compact fluorescent lamp: Power consumption = 12 W; approx. power cost per hour = 0.3 yen
Initial cost: Based on manufacturers' suggested retail prices; may vary from store to store
Power cost (incl. tax): 22.86 yen/kWh; second tier meter rate lighting service B provided by Tokyo Electric Power Company (September, 2008)

1. Energy saving methods using device alone

1) How energy saving methods and devices correspond

When considering lighting energy efficiency, the first key is to select the light source and the device. While you should select devices with low energy consumption, in order to create the desired light environment, it is also necessary to adopt each device upon understanding its characteristics.

Fig. 4 shows energy saving methods for different light sources and devices and their corresponding lamps.

Fig. 4 Energy saving methods for light sources and devices and their corresponding lamps

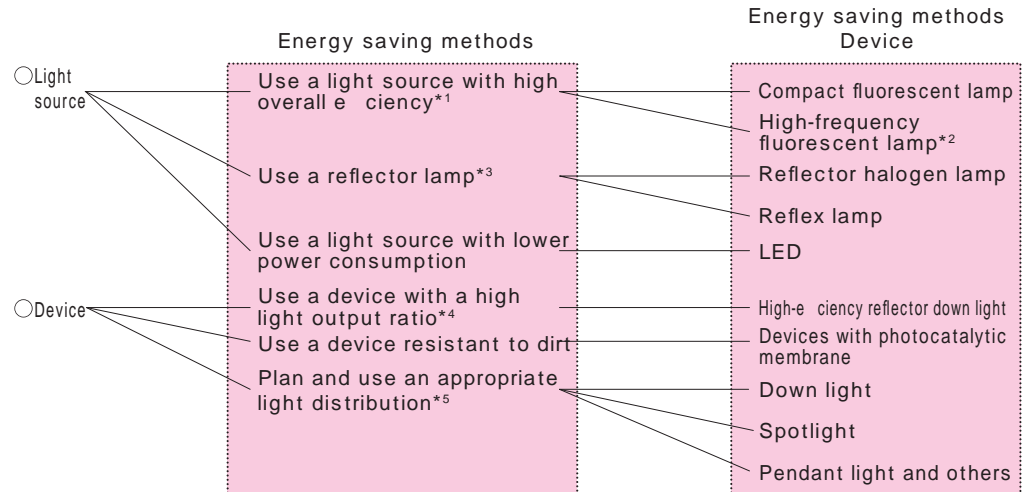

*1. Overall Efficiency
Denotes lamp light flux (light emitted by the lamp)/stabilizer input power and serves as the index for measuring the performance of a lamp and its stabilizer. (The higher the overall efficiency is, the better the energy saving effect will be.)
*2. High-frequency fluorescent lamp
Fluorescent lamp for high-frequency lighting. It increases the efficiency of the lamp by performing high-frequency lighting using an inverter as well as slimmer and longer tubes.
*3. Reflector lamp
Glass light bulb with a reflecting surface that increases the light distribution in a specific direction. It owes its high energy efficiency to its construction in which the light source and the device are one.
*4. Light output ratio
Denotes light flux emitted by lighting device/lamp light flux and serves as an index for measuring the performance of a device. (The higher the light output ratio is, the better the energy saving effect will be.)
*5. Light distribution
Distribution of light that describes how much light (luminosity) goes in which direction from the lamp or a device. See the data on light distribution provided by lighting device manufacturers.

Light distribution is indispensable when considering the distribution of brightness. Selecting the appropriate device requires a certain level of understanding of light distribution and a thorough familiarity with catalogs.

2) Types and characteristics of light sources

When selecting the light source, one needs to take into consideration the power consumption, light colors, and the product life. It is also important to select bulbs that are easy for the occupants to obtain and change.

The following shows the characteristics of the most common light sources.



Compact fluorescent lamp

<p>Type A</p> 	<p>Type D</p> 		
<p>Product life: 6,000 to 8,000 hours Power consumption/heat generation: Low (1/5 to 1/4 of a regular incandescent light bulb) Light color: Daylight (6,700 K), daylight white (5,000 K), regular (2,800 K) Availability: High</p>			

Characteristics

- Virtually the same size as regular incandescent light bulbs.
- Three light colors available (daylight, daylight white, and regular).
- Compatible with E26 base as well as E17 base.
- Power consumption is 1/5 to 1/4 of a regular incandescent light bulb.
- Product life is 6 to 10 times longer than that of regular incandescent light bulb.
- Some light bulbs of this type now allow dimming, which can be expected to contribute to energy conservation if these bulbs become popular.

High-frequency fluorescent lamp

<p>Straight tube type</p> 	<p>Circular type</p> 	<p>Double circular type</p> 
<p>Product life: 12,000 to 15,000 hours Power consumption/heat generation: Low Light color: Daylight (6,700 K), daylight white (5,000 K), white (4,200 K), warm white (3,500 K), and regular (3,000 K) Availability: Somewhat low</p>	<p>Product life: 9,000 to 12,000 hours Power consumption/heat generation: Low Light color: Daylight (6,700 K), daylight white (5,000 K), white (4,000 K), and regular (2,800 K) Availability: Somewhat low</p>	<p>Product life: 10,000 to 16,000 hours Power consumption/heat generation: Low Light color: Cool (6,700 K), natural (5,000 K), warm (3,200 K), and regular (3,000 K) Availability: Somewhat low</p>

Characteristics

- Allows for thinner device due to small diameter.
- Low power consumption.
- Long product life.
- Allows dimming (incremental dimming for circular-type).

5

Chapter 5 Energy-efficient Equipment Technology (Elemental Technology Application Method 3)

Reflector halogen lamp and reflex lamp

110V halogen lamp



Product life: 2,500 to 3,000 hours
Power consumption/heat generation: High
Light color: 3,000 K
Availability: Somewhat low

12V halogen lamp



Product life: 3,000 to 4,000 hours
Power consumption/heat generation: High
Light color: 3,000 K and 3,500 K (high color temperature)
Availability: Somewhat low

Reflex lamp



Product life: 1,000 to 2,000 hours
Power consumption/heat generation: High
Light color: 2,800 K
Availability: Somewhat low

Characteristics

- Allows for smaller opening diameter for down light.
- Allows occupants to change light distribution when changing light bulbs as reflector halogen lamps have different light distribution depending on shape of mirror (appearance is same).
- Halogen lamps are attractive and bright.
- Halogen lamps have high light-harvesting performance and create sharp contrasts in spaces.
- Although halogen lamps are not considered energy-efficient, they still offer better energy efficiency than regular incandescent light bulbs.

LED

Foot light



Down light



Desk lamp



Product life: 40,000 hours
Power consumption/heat generation: Low
Light color: Any
Availability: Low

Characteristics

- Long product life (40,000 hours).
- Low power consumption.
- Low heat generation.
- Allows for smaller devices.
- Can create any light color by mixing red, green and blue diodes when adjusting lighting.
- Potential next generation light source to replace incandescent light bulbs and fluorescent lamps.

* Although LEDs are currently not as energy-efficient as fluorescent lamps, their efficiency continues to improve. It is expected that sometime in 2009 or 2010, the efficiency of LEDs will be comparable to that of fluorescent lamps and will continue to improve. Presently, however, their initial cost is high, but may come down as they become more popular.

Another potential next generation light source is a surface-emitting organic electroluminescent, which can light a large area.

3) Types and characteristics of energy-efficient devices

In some cases, adopting high-performance devices after selecting an appropriate light source can further enhance the comfort and the energy saving effect. Some that fall under this category are devices that reflect the light from the light source with high efficiency and those that minimize the amount of dirt adhering to the light, which reduces the brightness.

High-efficiency reflector down light



Characteristics

- With evaporated silver.
- Produces cheerful and bright light.

Devices with photocatalytic membrane

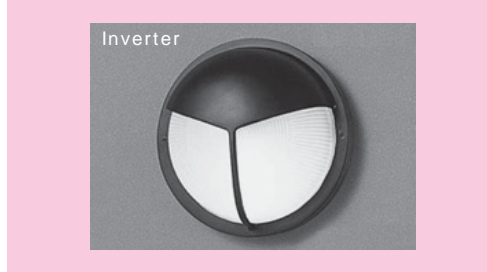

Characteristics

- The surface of glass cover is coated with photocatalytic membrane.
- Dirt adhering to surface is naturally broken down by photocatalytic decomposition.

4) Variation in light distribution according to types of lighting devices

The way the light spreads (light distribution) changes depending on the light source and the lighting device. Selecting a product that offers the desired brightness distribution for the same power consumption can therefore create a better light environment.

(1) Example of pendant light and bracket light

Pendant light (light distribution control type)



Characteristics

- Controls light distribution to provide bright light to table surface while also lighting space as well as people's faces appropriately.

Bracket (light distribution control type)

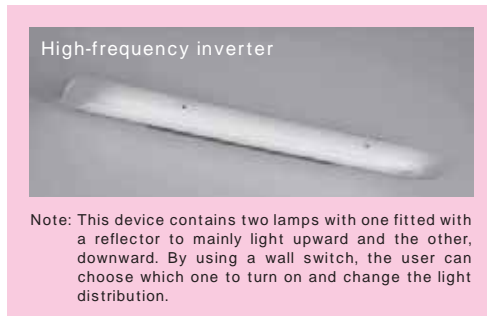

Characteristics

- Users can select three types of light distribution: "upward and downward", "upward", and "downward".

(2) Example of down light (when combining different devices and light sources)

The light distribution for a down light can vary greatly depending on the combination of the device and the light source. For example, a compact fluorescent lamp can light a surface evenly while a halogen lamp lights mainly directly below the device and its light does not cover a wide area.

Variation in light distribution for down light

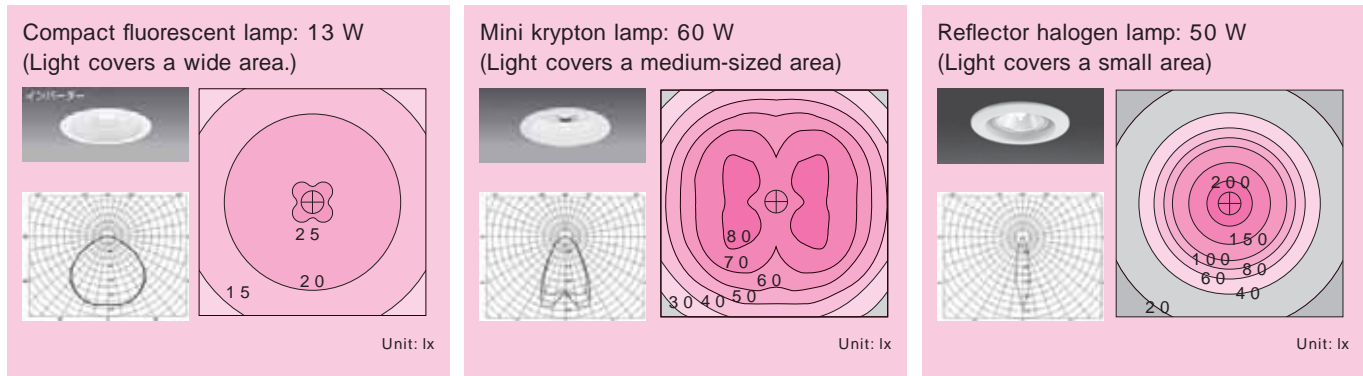

(3) Example of spotlight (when changing the light source while using the same device)

When using a spotlight with a light source with mirrors attached, even with the same device the light distribution can vary greatly, as shown below, depending on the light source. If the beam angle of the light source is wide, the light will spread widely while a small beam angle will concentrate the light on a smaller area.

Variation in light distribution for spotlight (halogen lamp: 50 W)

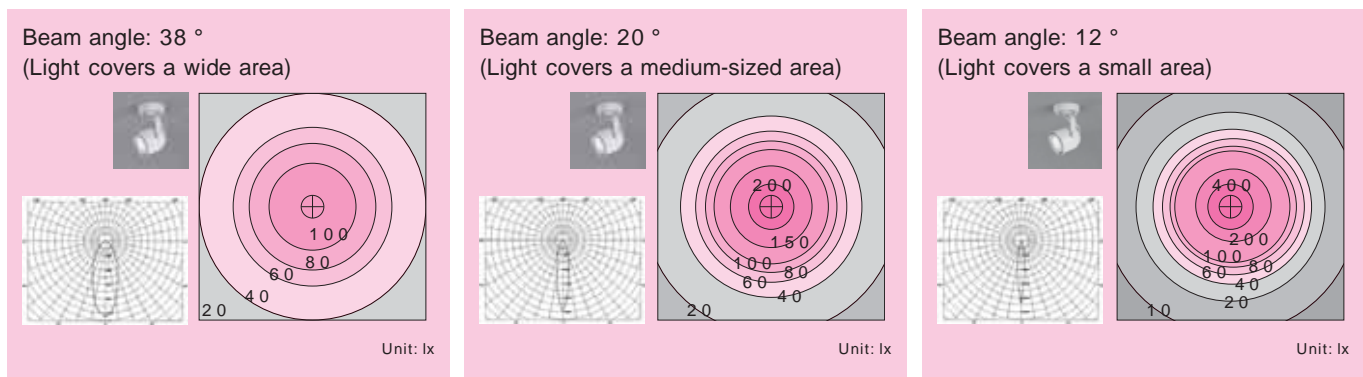

Key Point

Interpreting light distribution curve and illuminance distribution diagram

- A light distribution curve shows how the light radiates from a device.
- Numeric values found on the illuminance curve on an illuminance distribution diagram represent the illuminance value (unit: lx).

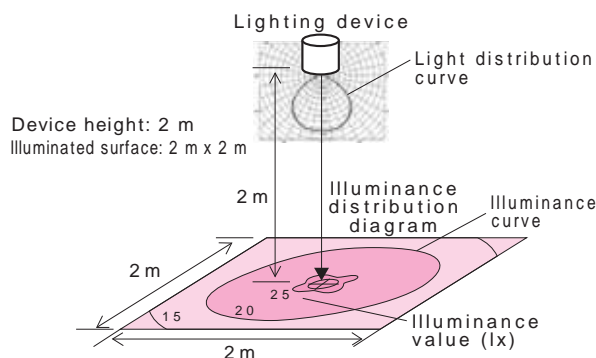















- The phrase “device height: 2 m” on the diagram on the left indicates the distance between the device and the illuminated surface. “Illuminated surface: 2 m x 2 m” indicates that the size of the illuminated surface on the illuminance distribution diagram is a square with 2 m-sides.

2. Examples of energy saving methods using devices alone

Table 2 shows examples of energy saving methods and their effects using light source or devices alone

Table 2 Examples of energy saving methods and their effects using devices alone

Example of energy saving method	Energy saving effect (Power reduction rate) ¹
Replace an incandescent light bulb (60 W) with a compact fluorescent lamp (13 W)  → 	78%
Replace a regular fluorescent lamp (40 W) with a high-frequency fluorescent lamp (32 W)  → 	20% Brightness up 14%
Replace a circular fluorescent lamp with a high-frequency double circular fluorescent lamp  →  Luminous efficacy = 57.1 (lm/W) Luminous efficacy = 102.9 (lm/W)	45%
Replace a regular halogen lamp in a down light with a 12 V reflector halogen lamp  →  85 W halogen down light 12 V 50 W halogen down light Average illuminance: 253 (lx) Average illuminance 291 (lx)	41% Brightness up 15% (Illuminance on the table surface) ² Conditions for the above calculation Device height: 2.0 m Table surface: 0.6 m x 1 m
Replace an incandescent light bulb (5 W) of a foot light with a LED (0.35 W)  → 	90%
Replace a regular down light with a high-efficiency reflector down light  →  Regular down light High-efficiency reflector down light Reflector: Off-white matt Reflector: Evaporated silver finish Lamp: 22 W compact fluorescent lamp Lamp: 22 W compact fluorescent lamp Average illuminance: 121 (lx) Average illuminance: 158 (lx)	0% Brightness up 31% (Illuminance on the floor surface) Conditions for the above calculation No. of lights: 4 Device height: 2.4 m Floor surface: 3.6 m x 3.6 m
Replace a wide-angle bulb (beam angle = 35°) with a medium-angle (beam angle = 20°) in a down light  →  40 W wide-angle halogen down light 30W medium-angle halogen down light Average illuminance: 113 (lx) Average illuminance: 149 (lx)	0% Brightness up 32% (Illuminance on the table surface) ² Conditions for the above calculation Device height: 2.0 m Table surface: 0.6 m x 1 m

1. Power reduction rate (%) = 1 - (power consumption after replacement / power consumption before replacement)
 2. It is also necessary to consider the illuminance distribution on the table surface when designing lighting.

Points of caution
 Although a halogen lamp is not considered a high-efficiency lamp, it still offers better efficiency than an incandescent light bulb. Here, an example is presented using a reflector lamp to increase the efficiency. This bright lamp is effective for locations where attractiveness is to be enhanced.

5

Method 2 : Method using operation and control

Frequently turning the lights off and dimming the lighting are directly linked to energy saving; however, this manual system is dependent on the occupants' consciously performing the task and is likely to increase the frequency of forgetting to turning off the lights. It is therefore necessary to install an automatic control system to prevent the lighting from being left on especially for rooms that people tend not to stay in for a long period of time. Three examples of effective control systems are: a timer control that keeps the lights on for a set period of time only; a motion sensor control that detects body heat or movement, and an illuminance sensor control that detects daylight.

1. Energy saving by methods of control

1) Types of methods of control

It is important to consider these various types of methods of control shown below while keeping in mind the lighting placement plan (Fig. 5, Table 3). If the purpose of the lighting is not compatible with its method of control, it may be inconvenient to use or may even be detrimental to safety. Careful consideration is especially required for locations such as stairs and steps where lack of appropriate lighting at one's feet can lead to a fall and other accidents.

Fig. 5 Types of methods of control

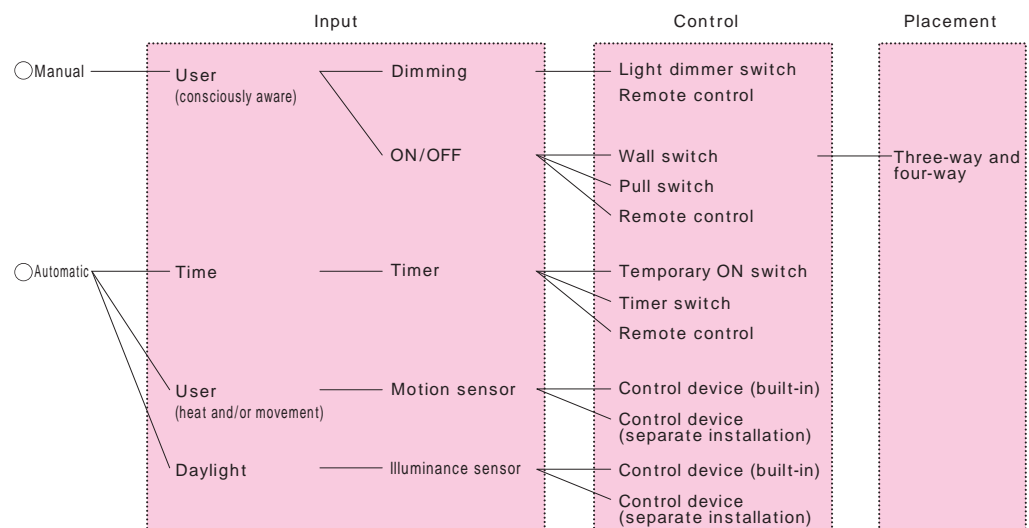

Light source that allows dimming. Among common light sources used in homes, incandescent light bulbs and high-frequency fluorescent lamps allow dimming.

Table 3 Characteristics of methods of control and their energy saving effect

Method of control	Action	Advantage	Disadvantage	Energy saving effect
Light dimmer switch	Users dim light manually when necessary.	Can set light at most appropriate brightness.	Large switch plate	Small to medium
Remote control	Controls multiple devices on one mobile remote control.	User is not required to move to switch.	Losing the remote control is inconvenient; requires standby energy.	Small to medium
Timer	Keeps the light on for set period of time only.	No wasteful operation.	Requires users to set time period.	Small
Motion sensor	Detects body heat and/or movement of users.	No wasteful operation.	Turns off if no movement is detected.	Small to medium
Illuminance sensor	Detects illuminance (daylight).	No wasteful operation.	Does not detect accurate illuminance unless it is appropriately positioned.	Medium

2) Characteristics of methods of control

Light dimmer switch

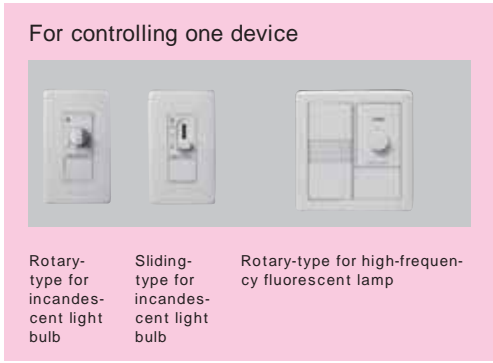

* Although few, there are some models of light dimmer switches that are compatible with both compact fluorescent lamps and incandescent light bulbs.

Characteristics

- Users can set default dimming settings for multiple devices and store them in memory, recalling them with a push of a button.
- Compatible with incandescent light bulbs and high-frequency fluorescent lamps.

Remote control



Characteristics

- Remote controls have built-in receivers to control lighting devices at distances.
- Each remote control is dedicated to one specific lighting device.

Characteristics

- Used in conjunction with dedicated adapter, one remote control can be used to operate multiple lighting devices that did not come with remote controls.

Timer



Characteristics

- This switch turns off light automatically after set period of time.

Characteristics

- Allows for pre-settings for ON or OFF times.

Note: Rooms and locations indicated in () are those for which these devices are recommended.

5

Chapter 5
Energy-efficient Equipment
Technology
(Elemental Technology
Application Method 3)

Motion sensor

Built-in-type



(Porch, kitchen sink, closet)
The device in the photo is for a porch.

Characteristics

- Has built-in motion sensor that turns light on automatically when it detects body heat. It then turns off after set period of time.

Separate installation type



Characteristics

- Multiple detectors can be connected to the main unit.

Illuminance sensor

Built-in type



(Porch, outdoor)

Characteristics

- Has built-in illuminance sensor that turns the light off or on automatically when it detects illuminance or lack thereof.

Separate installation-type



Characteristics

- Depending on amount of daylight, it maintains certain level of illuminance by turning multiple devices on and off or dimming lighting.
- This type is currently more common in offices but is expected to be more popular in homes in the future.

Note: Rooms and locations indicated in () are those for which these devices are recommended.

2. Examples of energy saving design by methods of control

The following are design examples using motion sensors and illuminance sensors (Fig. 6).

1) Design example of motion sensor (separate installation)

This design example is based on a scenario where the lights are turned on and off by motion sensors. A motion sensor-controlled bracket light is installed at the entrance porch while a motion sensor-controlled down light is located at the back entrance under the eaves.

A motion detector is installed for each lighting device so as to separately control the porch light and the back entrance light for people approaching either the front or back entrance from outside. Determine the installation location for motion detectors after considering the flow line as well as the detection range of the sensor. A single main unit controls the various settings for multiple detectors connected to it. Furthermore, since motion sensor switches commonly have a built-in illuminance sensor, they can be set to not operate during daylight hours.

2) Design example of illuminance sensor (separate installation)

This design example is based on a scenario where the down lights are turned on and off in the living room and the kitchen by illuminance sensors that detect daylight.

In the living room, one illuminance sensor controls two circuits, each featuring two lights, while in the kitchen another illuminance sensor controls a single circuit featuring one light. The illuminance is set on two settings (high and low) in the living room with the high setting corresponding to the down light at the back of the room (Circuit 1) and the low setting to the down light by the windows (Circuit 2). With these settings, when it begins to grow dark outside, the down light at the back of the room turns on, while the down lights by the windows turn on only when it is very dark outside. The illuminance setting for the down light in the kitchen is set to turn the on when the light from the skylight grows weak. For both locations, the light can also be turned on manually using the wall switches. This system is not currently feasible from the cost-efficiency point of view; however, a less expensive daylight utilization system for home use may be developed in the near future.

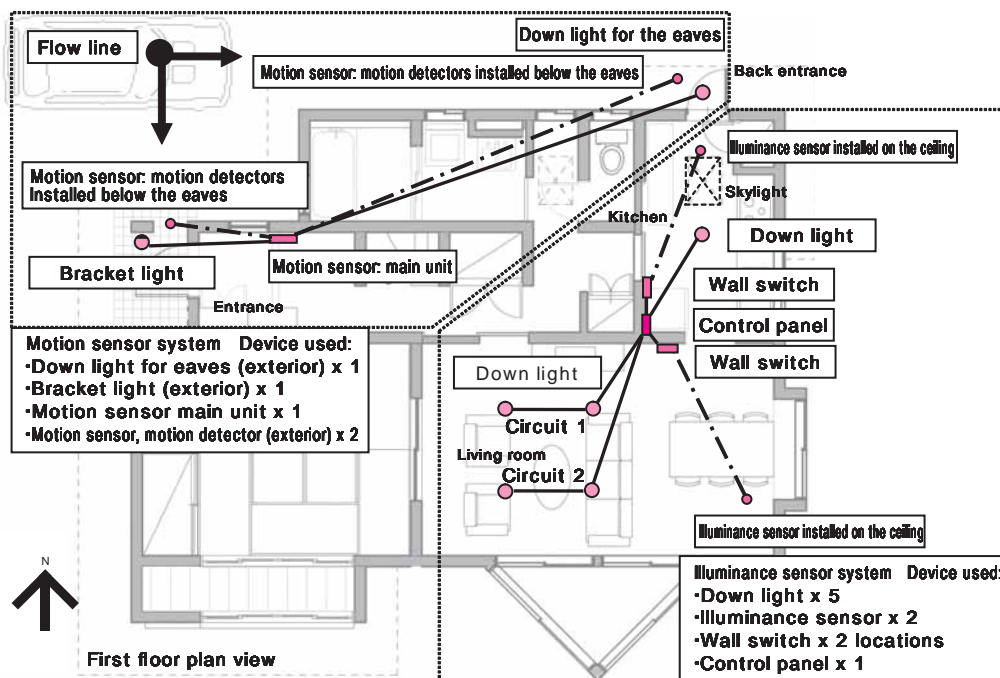

Fig. 6 Energy saving design example using motion sensors and illuminance sensors

Points of caution
The desired functioning of lighting devices can only be obtained when the detection range of motion sensors is appropriately adjusted.

Points of caution
Set up illuminance sensors where they are not affected by direct sunlight or other illuminance devices.

5

Method 3 : Method using design

Using either the one-light-per-room or the distributed multiple lighting system depending on the purpose or the actions that take place in the room is an effective way of saving energy as well as enhancing the light environment. As mentioned previously, the one-light-per-room lighting system is the conventional method that places one lighting device near the center of the ceiling while the distributed multiple lighting system spreads multiple lighting devices around the room with detailed settings determining the lighting pattern.

The advantages and effects of adopting the distributed multiple lighting system are as follows.

- The amount of artificial lighting required varies between the daytime and the evening and is also dependent on the actions that take place in the space. In a function-based room such as the bathroom and the toilet, the one-light-per-room lighting system is the norm, as actions that take place in the space do not vary. In a room such as the living room and bedrooms, however, actions can vary and adopting the distributed multiple lighting system may be necessary, as it allows multiple lighting patterns.
- By adopting the distributed multiple lighting system, wasteful lighting in locations and time periods can be reduced, which is extremely effective from the energy efficiency point of view. Furthermore, the quality of the light environment may also be improved, as it is easier to create the most appropriate light environment depending on the action.
- When using the distributed multiple lighting system, the occupants are required to select a lighting pattern for each action. This may create a situation, if the occupants are not overly concerned about being careful, in which most of the lights are almost always on without making use of the different lighting patterns. When using the system with many lighting devices, the range of the energy saving effect will therefore be very wide depending on how it is operated. The more lighting devices are used, the wider the range of this effect will be. It is thus essential for you to carefully discuss this with the occupants and be responsible in recommending a detailed lighting schedule according to their lifestyle. Ensure also, when planning, that the maximum power consumption (the total wattage of all lighting devices) is not excessive (See “Comment” later in the chapter).
- See pp. 291 – 293 for the steps in designing.

The following are the results of an evaluation concerning the light environment as well as the energy saving effect of the one-light-per-room lighting system and the distributed multiple lighting system, based on design examples prepared for realistic living and dining rooms.

The design examples do not take daylight into consideration but rather attempt to improve the light environment using artificial lighting while being energy efficient. Note that the evaluation of the energy saving effect was based on the lighting schedule for five hours in the evening until bedtime (18:00 to 23:00). Table 4 shows the overview of each design example.

Table 4 Overview of design examples

Plan type	Lighting device	Power consumption ratio	Characteristics
Design example 1: One-light-per-room plan (one-light-per-room lighting system)	2 types/2 lights	100%	This is a conventional plan with one device placed near the center of the ceiling. Problematic for both the light environment and energy efficiency.
Design example 2: Simple distributed multiple lighting plan (distributed multiple lighting system 1)	3 types/5 lights	75 90%	This plan adds auxiliary lighting to the one-light-per-room plan. By using an energy-efficient device that allows dimming, energy saving effects can be expected. Auxiliary lighting also enhances the light environment.
Design example 3: Plan reducing ceiling lighting to minimum (distributed multiple lighting system 2)	4 types/7 lights	65 90%	This plan mainly uses indirect lighting and puts emphasis on creating an atmosphere. Although the quality of the light environment is enhanced, power consumption can be high depending on the way the system is operated.
Design example 4: Plan that allows for various moods (distributed multiple lighting system 3)	5 types/9 lights	65 90%	This plan spreads small lighting devices around and allows for various moods to be created. It allows the occupants to select the most appropriate light environment. However, if their awareness toward the light environment is minimal, it may cause power consumption to rise due to a possible increase in wasteful lighting.

Design example 1: One-light-per-room lighting system in living and dining rooms

【One-light-per-room lighting plan】

With the one-light-per-room lighting system, it is most common to use a ceiling light in the living room and a pendant light in the dining room.

As the lighting devices are positioned in the center of the room, the impression of the room lacks contrast and appears rather flat. The light environment is strictly functional its quality is rather poor.

Furthermore, there is much wasteful lighting as areas where light is not needed are brightly lit and the ON/OFF-only control keeps the area bright until right up until bedtime.

The reason for the popularity of this lighting system is the ease of installation and exchange of lighting devices and light bulbs. It also does not require a detailed lighting design. This system, however, is problematic for both the light environment and the energy efficiency.

Disadvantages of one-light-per-room lighting system

- Some areas are lit unnecessarily.
- Wasteful lighting for some time periods.
- Cannot create appropriate light environment tailored to each room's purpose.

Actions likely to take place in the living room

- Family time, watching TV, listening to music, reading, entertaining guests, etc.

Actions likely to take place in the dining room

- Meals, family time, etc.

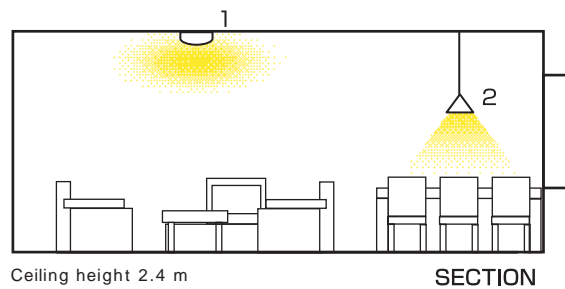
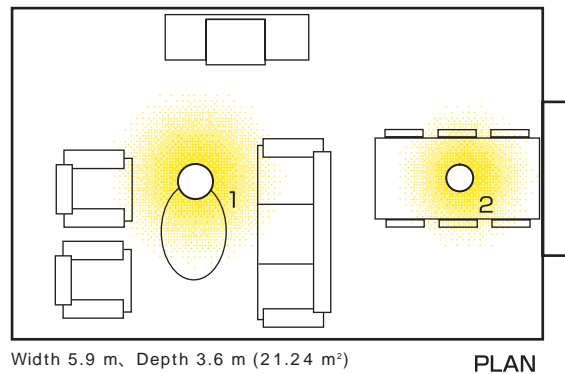

Table a Light environment

	Characteristics	Device number
Functions	• Illuminance on table surface (200 lx)	1, 2
	• Brightness on faces	1, 2
Atmosphere	• Bright feel of the space	1
	• Cheerfulness	-
	• Calm	-
	• Sense of rhythm	-
	• Fun	-

Table b Energy saving effect

Device	Lamp	No. of lights	Power consumption (W)	Total power consumption (Wh)	Power consumption ratio*
1	Ceiling 72W circular fluorescent lamp	1	70	280	
2	Pendant light 100W incandescent light bulb	1	90	90	
				370	100%

*See "How to calculate power consumption ratio" on p.309 for details on the total power consumption and the power consumption ratio.

5

Design example 2: Distributed multiple lighting system 1 in living and dining rooms

【Simple distributed multiple lighting plan】

A simple distributed multiple lighting system can be created, for example, by positioning a ceiling light at the center of the ceiling and adding some auxiliary lighting such as a floor lamp.

When doing so, it is important from the point of view of energy efficiency to either select a lower wattage for the ceiling light or lighting that allows dimming.

The quality of the light environment, however, is not excellent as the ceiling light at the center of the ceiling illuminates the table surface, providing even lighting and a flat impression to the whole space.

The dining pendant in this plan has several lights so as to allow for varied lighting patterns depending on the situation, which gives the space some contrast. Furthermore, low lighting such as a floor lamp can create a calm space.

- Key points of distributed multiple lighting system
- Can provide necessary amount of brightness where it is needed.
 - Can create moods appropriate for activities.
 - Can reduce wasteful power consumption.

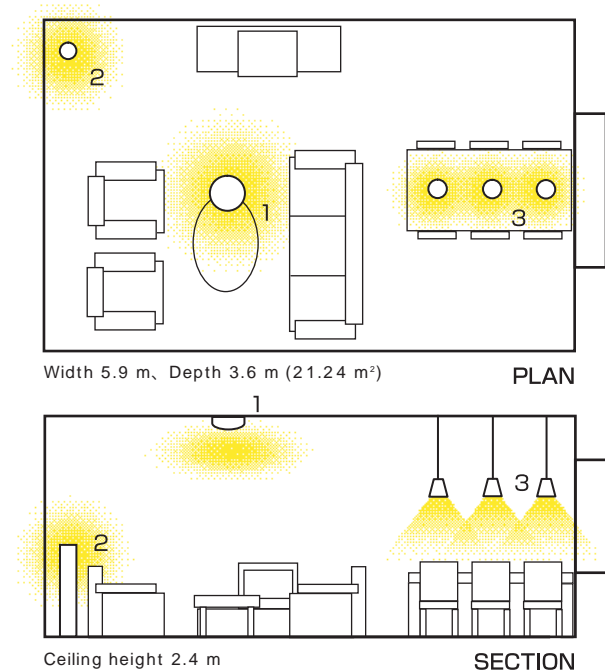

Mood example 1: All lights on



Mood example 2: Relaxing, etc.
(ceiling light 70% + floor lamp on low + 1 pendant on)

Table a Light environment

	Characteristics	Device number
Functions	• Illuminance on table surface (200 lx)	1, 3
	• Brightness on faces	1, 3
Atmosphere	• Bright feel of the space	1
	• Cheerfulness	-
	• Calm	2
	• Sense of rhythm	3
	• Fun	-

Table b Energy saving effect

Device	Lamp	No. of lights	Power consumption (W)	Total power consumption (Wh)	Power consumption ratio*
1 Ceiling	85W circular fluorescent lamp (dimmable)	1	77	250 ~ 273	Total power consumption in design example 2/Total power consumption in design example 1
2 Floor lamp	8W compact fluorescent lamps x2	1	16	8 ~ 36	
3 Pendant	8W compact fluorescent lamp	3	24	18 ~ 24	
				276 ~ 333	Approx. 75 ~ 90%

*See "How to calculate power consumption ratio" on p.309 for details on the total power consumption and the power consumption ratio.

Design example 3: Distributed multiple lighting system 2 in living and dining rooms

【Plan reducing ceiling lighting to minimum】

Besides multiplying the lighting from the ceiling, the distributed multiple lighting system can also disperse the light to the walls and floor.

Brightening up the walls, which can be done for example with indirect lighting, is especially effective in enhancing the overall brightness. When doing so, it is important to ensure that the wall surfaces are matt white in color with a high reflectance.

Using indirect lighting to obtain brightness on the table surface, however, can lead to more energy consumption. Selecting the type of indirect lighting that allows dimming is therefore recommended.

Furthermore, place down lighting and pendant lighting where brightness is needed.

Placing accent lighting such as a desk lamp can create a livelier atmosphere in the space where it tends to be flat.

Key points of distributed multiple lighting system

- Functional lighting and atmosphere lighting are designed separately.
- Takes light balance into consideration.
- Also takes the interior (colors and materials) into consideration.
- Switches are placed clustered together.

Table a Light environment

	Characteristics	Device number
Functions	• Illuminance on table surface (200 lx)	1, 2, 3
	• Brightness on faces	1, 3
Atmosphere	• Bright feel of the space	2
	• Cheerfulness	-
	• Calm	-
	• Sense of rhythm	-
	• Fun	4

Table b Energy saving effect

Device	Lamp	No. of lights	Power consumption (W)	Total power consumption (Wh)	Power consumption ratio*
1	Down light	8W Compact fluorescent lamp	4	32	95 ~ 112
2	Indirect lighting	LED Table lamp (dimnable)	1	80	120 ~ 208
3	Pendant	22W compact fluorescent lamp	1	22	22
4	Desk lamp	8W compact fluorescent lamp	1	8	4 ~ 8
				241 ~ 350	Approx. 65 95%

*See "How to calculate power consumption ratio" on p.309 for details on the total power consumption and the power consumption ratio.

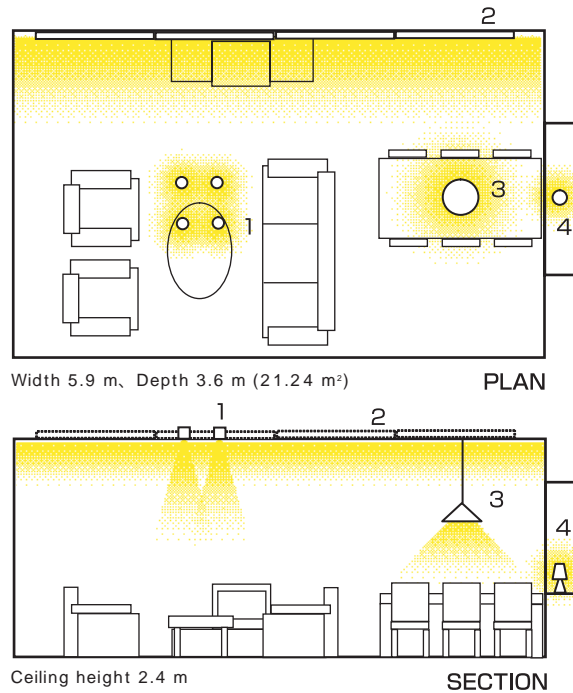

Mood example 1: All lights on



Mood example 2: Watching a movie, etc.
(down light x 2 + indirect lighting 50%)

5

Chapter 5
Energy-efficient Equipment
Technology
(Elemental Technology
Application Method 3)

Design example 4: Distributed multiple lighting system 3 in living and dining rooms

【Plan that allows for various moods】

This plan allows the user to create various moods by turning on different combinations of lights.

Turning on the chandelier and the LED down light gives the room a cheerful atmosphere for special occasions such as when entertaining guests. Using the LED down light only can provide the room with an overall darkness as well as the minimum required light by dimming, which is suited for activities that take place in the dark such as watching a movie. Combining the LED down light and the floor lamp gives the space a calm atmosphere with enough local light, which is ideal for reading and other similar activities.

LED lamps enhance the attractiveness of the space by giving it a shimmering look. They also have a high light-harvesting performance and give the space a contrast. They are, in other words, effective in enhancing the quality of the light environment. They are however currently not commonly used due to their high prices, but this may come down as they become more popular.

Key points of distributed multiple lighting system

- Ensure the total wattage is not excessive.
- Do not add too many different types of lamps.
- Discussion with the occupants is essential.

Table a Light environment

	Characteristics	Device number
Functions	• Illuminance on table surface (200 lx)	1, 2, 4
	• Brightness on faces	1, 4
Atmosphere	• Bright feel of the space	1
	• Cheerfulness	1, 2
	• Calm	3
	• Sense of rhythm	4
	• Fun	5

Table b Energy saving effect

Device	Lamp	No. of lights	Power consumption (W)	Total power consumption (Wh)	Power consumption ratio*
1 Chandelier	13W compact fluorescent lamp x4	1	52	156 ~ 208	Total power consumption in design example 4/Total power consumption in design example 1
2 Down light	5W LED (dimnable)	4	20	32 ~ 52	
3 Floor lamp	8W compact fluorescent lamps x2	1	16	24 ~ 40	
4 Pendant	12W compact fluorescent lamp	2	24	24	
5 Desk lamp	8W compact fluorescent lamp	1	8	4 ~ 8	
				240 ~ 332	Approx. 65 90%

*See "How to calculate power consumption ratio" on p.309 for details on the total power consumption and the power consumption ratio.

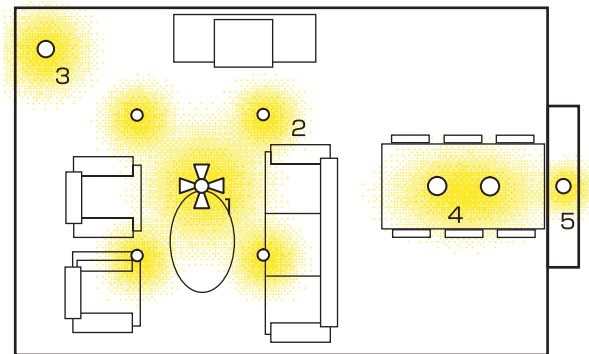

Width 5.9 m, Depth 3.6 m (21.24 m²)

PLAN



Mood example 1: All lights on



Mood example 2: Family time, etc. (chandelier + pendant x 1)



Mood example 3: Watching a movie etc. (down light 50% + floor lamp on low + desk lamp)

Key Point

How to calculate power consumption ratio for design examples

- Power consumption ratio (%) expresses the ratio of power consumption planned for the distributed multiple lighting system compared with that of the conventional one-light-per-room lighting system.

$$\text{Power consumption ratio} = \frac{\text{Total Power consumption for distributed multiple lighting system}}{\text{Total power consumption for conventional one-light-per-room lighting system}}$$

- The total power consumption (Wh) is calculated using the following formula.
Total power consumption = (power consumption of the single device x the switch-on ratio of the device)
- The switch-on ratio takes into consideration the hours the device was switched on as well as the dimming ratio, and is calculated using the following formula.
Switch-on ratio = hours turned on x dimming ratio when on
- The dimming ratio also applies when using only some of identical multiple lighting devices or some of multiple lamps of one lighting device. For example, the dimming ratio when only two lamps of the three-lamp pendant light are used is $2/3=0.66=66\%$.
The following is an example calculation for design example 2.

Table a Lighting devices used

Design example	Lighting device	Lamp	# of lamps	Power consumption (W)	Hours on (h) x dimming ratio
Design example 1: base plan	1. Ceiling	72W circular fluorescent lamp	1	70	4 x 1
	2. Pendant	100W incandescent light bulb	1	90	1 x 1
Design example 2 (small): W/ smaller power consumption	1. Ceiling	85W circular fluorescent lamp	1	77	2.5 x 1 + 1.5 x 0.5
	2. Floor lamp	8W compact fluorescent lamp X2	1	16	1 x 0.5
	3. Pendant	8W compact fluorescent lamp	3	24	1 x 0.75
Design example 2 (large): W/ larger power consumption	1. Ceiling	85W circular fluorescent lamp	1	77	2.5 x 1 + 1.5 x 0.7
	2. Floor lamp	8W compact fluorescent lamp X2	1	16	1.5 x 1 + 1.5 x 0.5
	3. Pendant	8W compact fluorescent lamp	3	24	1 x 1

Table b Switch-on schedule

Design example	Lighting device	18:00	18:30	19:00	19:30	20:00	20:30	21:00	21:30	22:00	22:30	23:00
Design example 1: base plan	Ceiling	100				100						
	Pendant			100								
Design example 2 (small): W/ smaller power consumption	Ceiling	50		100			100				50	
	Floor lamp									50		
	Pendant			75								
Design example 2 (large): W/ larger power consumption	Ceiling	70		100			100				70	
	Floor lamp									50		
	Pendant			100								

Note: The solid line denotes that the device was turned on and the value above the line indicates the dimming ratio (%).

Comment How to plan distributed multiple lighting well

When planning distributed multiple lighting, if you start with the assumption of installing the lighting using a particular kind of scenario based on the total power consumption in watts, you may be so overwhelmed that you will be at a loss as to where to start.

Therefore, it will be helpful to first bring down the wattage of the lighting device placed in the center of the room and then to distribute the wattage reduced to the down lights and lamps.

This way, in most households, a distributed multiple lighting can easily be achieved without increasing the power consumption of everyday life.

If the use of a ceiling light for a one-light-per-room system is to be retained, consideration should be given to adjusting the level of lighting lower and setting this as the norm; the wattage reduced should then be distributed to other lighting devices.

5

Chapter 5 Energy-efficient Equipment Technology (Elemental Technology Application Method 3)

5.6 Adopting High-efficiency Consumer Electronics

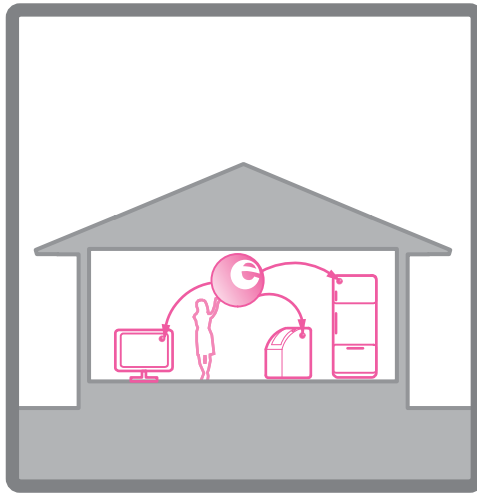

Although space cooling and heating along with lighting account for the majority of the power consumption in a household, approximately 30% of consumption is by consumer electronics such as televisions and refrigerators. These consumer electronics are becoming increasingly energy efficient to address society's demand for energy conservation. A significant improvement has thus been made on their energy performance while in use as well as when on standby.

Reducing the energy consumption of an entire household can be realized by gathering appropriate information when replacing consumer electronics.

5.6.1 Key Points for Adopting or Replacing High-efficiency Consumer Electronics

- When purchasing new or replacing old consumer electronics, in addition to the functions and the price, considering energy efficiency of the products will lead to energy conservation and reduced running costs.
- From the point of view of LCC and $LCCO_2$, purchasing new consumer electronics is not necessarily always recommended when the cost associated with replacing and the energy consumed for manufacturing the product are taken into account. However, in some cases, depending on the type and the age of the consumer electronics, the initial cost and the energy consumed by manufacturing process can be recovered in several years by replacing.
- When replacing consumer electronics, the cost effectiveness and energy benefit can vary greatly depending on the types of consumer electronics as well as their condition and how they are used. It is therefore important to estimate the reduction in running cost and the energy saving effect by perusing documents such as catalogs before making a decision.

5.6.2 Energy Conservation Target Levels for Adopting High-efficiency Consumer Electronics

1. Definition of target levels

The levels for adopting high-efficiency consumer electronics are based on the energy consumption by consumer electronics found in an average household in 2000. The following table shows the reduction rates.

Level - 1	: Approx. 40% increase compared with typical energy consumption in 2000
Level 0	: Typical energy consumption in 2000
Level 1	: Approx. 20% reduction compared with typical energy consumption in 2000
Level 2	: Approx. 40% reduction compared with typical energy consumption in 2000

All target levels can be achieved by taking energy saving measures such as replacing consumer electronics that have high energy consumption with high-efficiency ones.

Glossary: LCC and $LCCO_2$
The acronym LCC stands for "Life Cycle Cost", which is the total sum of cost required for the entire life process of industrial products and buildings, from the manufacturing and actual use of the product or building, right up to its disposal or demolition. LCC also includes all the costs associated with material procurement, construction, management, maintenance, repair, and scrapping.

$LCCO_2$ stands for "Life Cycle Carbon Dioxide" and represents the amount of CO_2 emission during the above-mentioned process.

Note

Some manufacturers of consumer electronics offer on their websites an application to calculate the estimated running costs.

<http://panasonic.jp/eco/kaikae/>

2. Requirements for achieving target levels

1) Facts about types of consumer electronics and energy consumption

Fig. 1 shows the breakdown of energy consumption by consumer electronics in a typical household (in Naha and Kagoshima). Power consumption is much greater for certain types of consumer electronics such as refrigerators and televisions (two televisions per household), each exceeding 30% (or 60% together) of the entire power consumption by consumer electronics. These two, along with hot water heated toilet seats and washing machines, account for nearly 80% of the total power consumption by consumer electronics.

Although appliances such as space cooling and heating devices and domestic hot water devices do consume electric power, it is important to carefully consider general consumer electronics, which account for roughly 30% of all energy consumption (or 40% of electric power consumption), in order to effectively achieve energy conservation. Consumer electronics that account for a high share of power consumption mentioned above need to be the first to be replaced with higher-efficiency models.

Fig. 2 (found on the next page) shows the power consumption by a conventional device as well as by an energy-efficient replacement and the reduction in power consumption for consumer electronics with high power consumption most common in households. The power consumption shown is the total annual power consumption (kWh per year) and the reduction is indicated using %. The reduction shown here is the result of comparing products from 1997 and 2003. Most energy-efficient technologies for devices such as refrigerators were well established by 2001 and the improvements thereafter have been minimal. Energy-efficient technologies in this area have been developed in discontinuous phases rather than small yearly increments and the timing of these phases differs depending on the kind of consumer electronics.

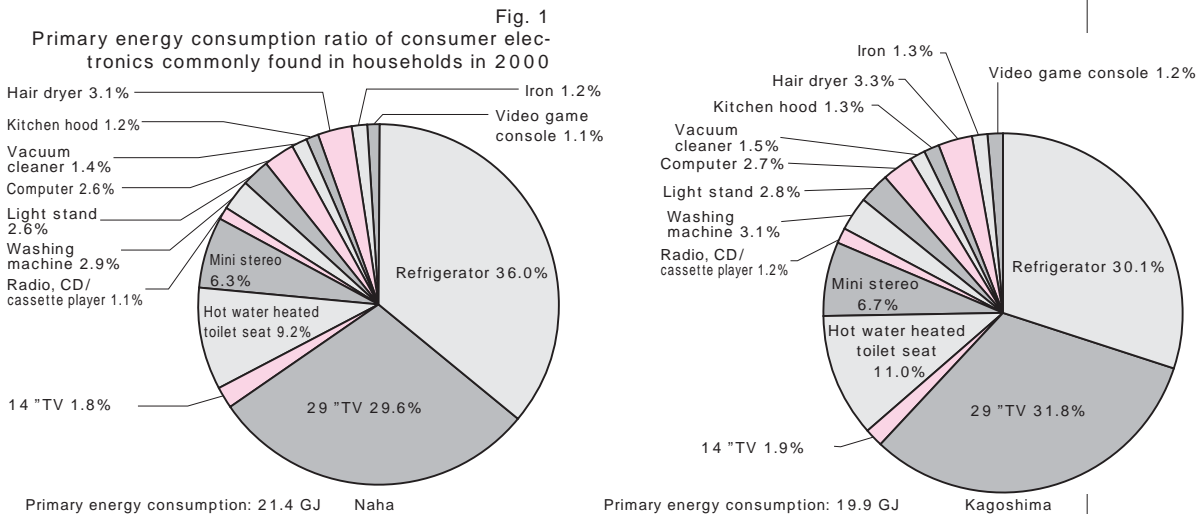

- These pie charts are based on the calculations using the energy consumption data obtained from conducting the validation experiment during which consumer electronics were actually operated. The weather conditions in Naha and Kagoshima were then taken into consideration.
- During the validation experiment, a full-scale test house (Kanto region) was used to recreate the life of an average four-person household including consumer electronics ownership, their daily schedules, and the use of these devices. It recreated energy consumption and heat generation that occur within the household throughout the year and measured the realistic energy consumption and the effects of energy saving methods.
- Some consumer electronics and their energy consumption can be affected by the outside conditions in hot humid regions. To calculate energy consumption for those devices, weather conditions in Naha or Kagoshima (Expanded AMeDAS Weather Data 1981 – 2000) were applied to the relational expression between various energy consumption figures and the outside air temperature, the room temperature, and the water temperature obtained through the validation experiment.

5

Chapter 5 Energy-efficient Equipment Technology (Elemental Technology Application Method 3)

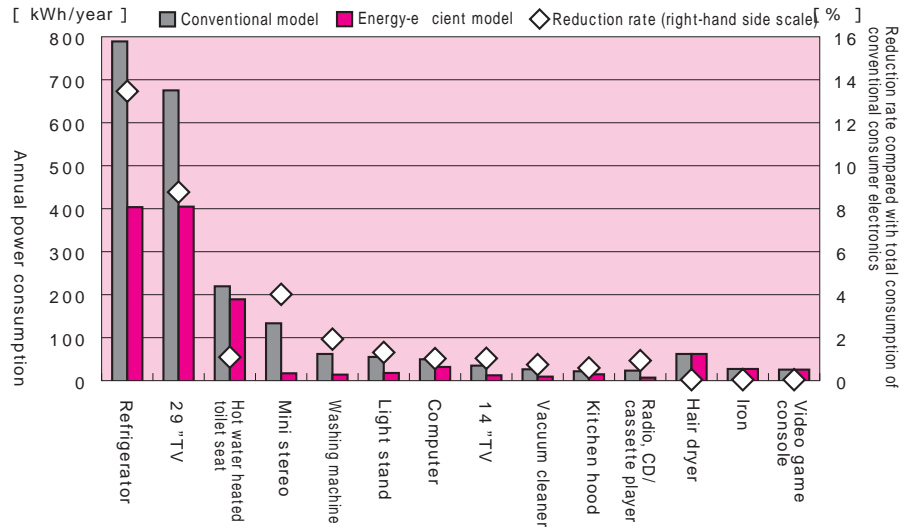

Fig. 2 Power consumption of conventional consumer electronics and reduction rate after adopting energy-efficient consumer electronics (Naha)

Conventional model = product with high market share in FY 1997.
 Energy-efficient model = most energy-efficient product available in FY 2003.
 In reality, the consumption pattern varies greatly from one household to another as products used for long periods of time consume more power.

- The validation experiment results shown above are for standard products selected from those available around 1997. Those with average efficiency were deemed appropriate after taking into consideration the consumer electronics ownership of an average household in 2000.
- The validation experiment results shown above for energy-efficient products in FY 2003 are for products with the best catalog energy performance of those sold in FY 2003.

2) Prime consumer electronics and priority consumer electronics

Of those general consumer electronics that account for a large percentage of the total energy consumption in a typical household, “prime consumer electronics” are defined as devices that are used for an extended period of time and tend to have high energy consumption. Refrigerators and televisions fall under this category. “Priority consumer electronics” are devices that can consume an unexpected amount of power depending on how they are used. Hot water heated toilet seats, electric hot water pots and washing machines fall under this category (Table 1).

Table 1 Prime consumer electronics and priority consumer electronics

Prime consumer electronics	1. Refrigerators 2. Televisions
Priority consumer electronics	3. Hot water heated toilet seats 4. Electric hot water pots 5. Washing machines

Furthermore, we have established the “energy-efficient device classification” based on the energy saving effect of the devices that fall under the categories of prime and priority consumer electronics. Energy-efficient device classification is divided into categories according to the year the device was manufactured, technologies, and power consumption. The classification also indicates the annual power consumption of the each category as well as the reduction in energy consumption when compared with a product manufactured in 2000 (See “1 Energy-efficient device classification for prime and priority consumer electronics and their characteristics” in Section 5.6.3 on p.316).

The most important factor in determining the energy saving effect achieved by replacing consumer electronics is the difference in performance between the product currently in use and the product that replaces it. The bigger the difference is between the two, the bigger the effect of replacing the current product.

However, as mentioned previously, the energy performance of consumer electronics does not improve in relation with time but rather tends to show drastic improvement when certain technologies are developed.

It is therefore crucial to determine whether the product was manufactured before or after the drastic improvement. As years and types of technologies that boosted the performance vary depending on the type of consumer electronics, consumers are encouraged to verify this information before making a decision.

Electric hot water pots, electric rice cookers, clothes dryers, and dishwashers also require a significant amount of power depending on how they are used. For example, an electric hot water pot, which is not insulated, consumes more than 80 W when keeping the water warm. This is comparable to the power consumption of a ventilation system for overall ventilation. Electric rice cookers also consume a lot of power when keeping the rice warm. In household where the family uses the “keep-warm” function for an extended period of time, it would be helpful to select an energy-efficient model. Although energy performance of clothes dryers cannot be simply compared as their drying methods differ from one dryer to another and no common index exists, small efforts such as using it less frequently or combining it with natural drying can reduce the power consumption. For dishwashers, selecting a water-saving model will limit the power required to supply hot water and conserve water resources.

Comment Energy consumption of hot water heated toilet seats in hot humid regions

Hot water heated toilet seats that are not energy efficient can consume an unexpected amount of energy in warm regions and are considered prime consumer electronics while they fall under priority consumer electronics in hot humid regions, reflecting the usage pattern in the area.

The figure below shows the comparison between the conventional hot water heated toi-

let seat and its energy-efficient counterpart. It can be surmised that the reason why conventional hot water heated toilet seats do not consume as much energy in hot humid regions is that the high temperature of both the air and the water supply make it less energy consuming to keep the toilet seat and washing water warm.

Fig. Relationship between outside air temperature and daily power consumption by heated toilet seat

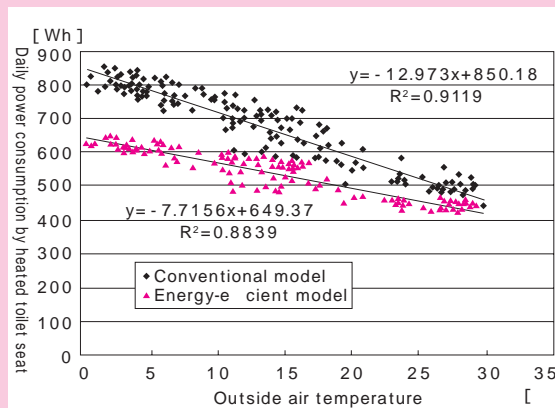

* When the outside air temperature is high, the energy saving effect is reduced.

5

3) Standby energy consumption

The consumer electronics device with the fourth largest power consumption is the mini stereo (See Fig. 1 on p.311); however, most of the power consumption occurs not when it is in use but as standby power. Standby power is consumed 24 hours a day and its amount greatly influences the power consumption of the device as a whole. For example, if a product consumes 1 W of standby power, the total consumption will be 8.76 kWh per year. Although the amount of standby power consumption varies greatly depending on the type of device and its rating, efforts have been made to minimize it as much as possible for most of the products sold after 2004. It should be noted, however, that some products that date back to the 1990s consume nearly 100 times more standby power than the current products.

Virtually all devices that remain plugged in consume standby power. Some examples other than prime and priority consumer electronics are mini stereos, stereos, tuners, DVD players, video cassette players, radio-CD-cassette players, computers, telephones, microwave ovens and video game consoles; especially those devices that come with remote controls, time display or AC adapters tend to consume a lot of power.

In most cases, the amount of standby power consumed is indicated on the device. Note that most products sold in recent years consume a minimal amount, approximately 0.1 W, of standby power. If a device consumes several watts of standby power, it would be wise to unplug it when it is not in use.

4) Devices that operate for extended periods of time

Similar to standby power consumption, if consumer electronics devices are used all day long or for extended periods of time, the total power consumption at the end of the day can be large even though the device is not high. Some examples of these devices are the increasingly popular network devices, air purifiers, and security devices.

At this point in time, it is difficult to find energy-efficiency measures for these consumer electronics as they are a new type of energy consumption born out of our new lifestyle in recent years. However, some basic rules such as not using devices unnecessarily and frequently turning them off when not in use do apply and being mindful as users remains important.

For reference purposes, Table 2 shows the amount of annual power consumption for products that are most common in recent years.

Table 2 Power consumption of consumer electronics used for extended periods of time

Device	Hours in use/year	Power consumption	Annual power consumption	Effect on power consumption of consumer electronics in 2000	Remarks
Wireless LAN, HUB, etc.	8,760	10 W	88 kWh	Increased 4.1	
Air purifier	500	12 W	6 kWh	Increased 0.3	In use for 4 hours/day, 125 days/year, 2.0 m ³ /minute
Fire alarm	8,760	2 W	17.5 kWh	Increased 0.82	

3. How to achieve target levels

The energy conservation target levels for adopting high-efficiency consumer electronics are based on the power consumption by consumer electronics owned by a typical household in 2000 and indicate the reduction rate. Table 3 shows the reduction rate as well as the amount of energy reduced.

The amount of energy reduced for prime and priority consumer electronics is calculated by adding all the figures for energy reduction indicated for energy-efficient device classification (Table 4 – 8). Furthermore, Level 2 requires measures against standby power consumption.

Table 3 Target levels for adopting high-efficiency consumer electronics

Target level	Energy saving effect (consumer electronics energy reduction rate)	Amount of energy reduced	Device classification for prime and priority consumer electronics used (example)																	
			Refrigerator				Television					Hot water heated toilet seat			Electric hot water pot					
			- 1	0	1	2	- 1	0	1	2	3	- 1	0	1	0	1				
Level - 1	Up approx. 40%	Approx. - 1,000 kWh (increase)																		
Level 0	0	None																		
Level 1	Approx. 20%	500 kWh or more																		
Level 2	Approx. 40% or more	1,000 kWh or more + amount reduced by adopting devices with low standby power consumption																		

* It is assumed that mini stereos and microwave ovens, etc., are those with low standby power consumption available from 2003 or later (See p.314).

- Many different combinations of devices are possible to achieve each energy conservation level for consumer electronics.
- As televisions are increasingly bigger and information devices more common, energy consumption by consumer electronics appears to be increasing. It is thus preferable to select products that are more energy efficient after considering their functions and performance.
- Some consumer electronics such as hair dryers and irons are difficult to make energy efficient; however, even then, it is still important to make the effort to select highly-efficient products with low standby power consumption whenever possible.

5

Chapter 5 Energy-efficient Equipment Technology (Elemental Technology Application Method 3)

5.6.3 Characteristics of Consumer Electronics and Points of Caution for Usage

1. Energy-efficient device classification for prime and priority consumer electronics and their characteristics

1) Refrigerators

Table 4 below shows the energy-efficient device classification for refrigerators (capacity of 400 L) using the power consumption of a product (inverter type) manufactured between 1995 and 2000 as the standard (Class 0).

Table 4 Energy-efficient device classification for refrigerators (400 L)

Device classification	Year manufactured	Technologies	Annual power consumption	Energy reduction	JIS indicated value of annual electricity consumption
Class - 1	Models up to 1994	No energy-efficient design	1,800 kWh	- 1,000 kWh (increase)	No display (800 kWh or more)
Class 0	1995 2000	Inverter	800 kWh	0 (Standard)	400 kWh
Class 1	2001 2006	High insulation performance (+ CFC free)	400 kWh	400 kWh	200 kWh
Class 2	Energy-efficient models in 2007	High insulation performance (+CFC free)	300 kWh	500 kWh	450 kWh (2006 JIS)

* JIS indicated value of annual electricity consumption quotes figures indicated in catalogs (See "Key Point" on this page). The figures for the annual power consumption as well as the energy reduction were obtained from the results of the validation experiment. (Based on a model manufactured in 1997: Class 1 is set at the values obtained through experiment using an energy-efficient model manufactured in 2003; the refrigerator door was never opened as per the condition of the validation experiment.)

- Class 0 (standard) is established using a model manufactured in 1997 with an annual power consumption of approximately 800 kWh.
- In terms of important energy-efficient technologies in refrigerators, the inverter compressor and the improved insulation performance have had a significant influence.
- Although energy consumption of refrigerators can vary depending on their capacity, generally speaking, the energy consumption increases in proportion with the capacity of the refrigerator. However, energy-efficient technologies tend to be implemented first in popular models that sell well. This means that a refrigerator with a smaller capacity may not be equipped with the energy-efficient technologies mentioned in the table above and its energy consumption may be larger.
- Power consumption of a refrigerator is closely linked to the temperature of its surroundings (ambient temperature), and the higher the temperature, the larger the power consumption. It is therefore advisable to avoid placing it at a location with direct sunlight. Good air circulation should also be ensured to efficiently eliminate the heat generated by the refrigerator.

Key Point

JIS indicated value of annual electricity consumption for refrigerator

- JIS revised its calculation standard for indicating annual power consumption for refrigerators on May 1, 2006. As shown on the figure below, when comparing the former indicated values to JIS2006 using models sold in FY 2006, all of them showed approximately 3.5 times more power consumption. Bear this in mind when comparing values between the former JIS and JIS2006. Note also that the difference in indicated values can vary depending on the size of the refrigerator since the indicated values for smaller models, unlike the larger models (400 L class), did not change much after the revision.
- Furthermore, when comparing the annual energy consumption indicated in catalogs and the results of the validation experiment, the difference was 2.1 times for the standard models manufactured in 1997 (380 kWh) and 2.2 times for energy-efficient models in 2003 (190 kWh). In other words, the estimated values for actual power consumption are approximately twice as much as the former JIS indicated values. Note that, among models with JIS2006 indicated values, the values for energy-efficient models (450 kWh) in 2007 were approximately 0.7 times greater than the results of the validation experiment. It is probable that this discrepancy is due to changes in measurement conditions and other factors.

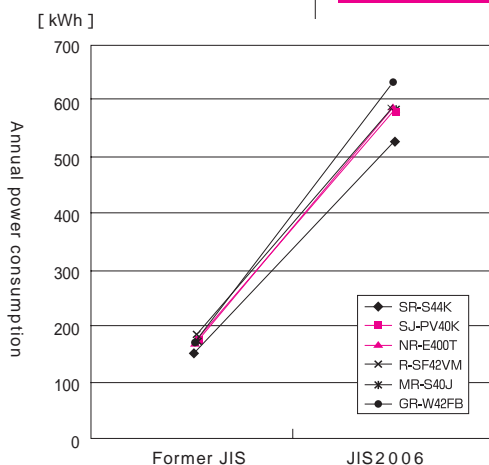

Fig. JIS indicated value for annual electricity consumption of refrigerators

2) Televisions

Televisions come in various types and sizes. Table 5 below shows the energy-efficient device classification based on measurements taken during the validation experiment using the power consumption of a CRT-based television manufactured in 1997 as the standard (Class 0).

Table 5 Energy-efficient device classification of televisions (28" and 37", CRT-based, plasma, LCD)

Device classification	Type/size/year	Annual power consumption	Energy reduction
Class - 1	37" plasma manufactured up to 2004	700 kWh (reference purposes)	- 50 kWh (increase; reference purposes)
Class - 1	37" plasma manufactured in 2007	900 kWh (reference purposes)	- 250 kWh (increase; reference purposes)
Class 0	28" CRT-based manufactured up to 2000	650 kWh	Standard
Class 0	37" LCD manufactured up to 2004	650 kWh	0 kWh
Class 1	37" LCD manufactured in 2007	550 kWh	100 kWh
Class 2	28" LCD manufactured up to 2000	450 kWh	200 kWh
Class 3	28" LCD manufactured between 2001 and 2003	400 kWh	250 kWh
Class 3	28" LCD manufactured from 2004 onward	370 kWh	280 kWh

* Results for CRT-based TV were based on actual measurements estimating average of 8.3 hours of daily use. As larger sizes are the norm for plasma TVs, the results for 37"-sized models were shown here for reference purposes. Those figures were calculated using catalogs and based on the JEITA standards with estimated 8.3 hours of daily use. The results for the LCD TVs were based on actual measurements estimating an average of 8.3 hours of daily use.

- Energy-efficient technologies available for televisions include “minimizing standby power consumption”, “LCD TVs”, and reducing the power consumption of tuners. It is therefore preferable to select a product that is equipped with those technologies.
- In recent years, we are seeing an increasing number of large-size televisions. Bear in mind that, even if they are LCD TVs that consume a relatively small amount of energy, large televisions will consume much energy when in use.

Key Point

Changes in power consumption of televisions according to brightness of surroundings

- Wattage of televisions varies depending on the brightness setting of the screen (Fig.).
- The required brightness of the screen also varies depending on the condition of the surroundings and the program content. Making the surroundings as dark as possible can reduce the required brightness of the screen and lead to energy efficiency. In some cases, the reduction rate exceeds 50%.
- Many newer televisions are equipped with a function that automatically adjusts the brightness of the screen according to the brightness of the surroundings. Energy efficiency can be achieved by making use of such functions while taking into consideration the daylighting and lighting methods when watching the television.

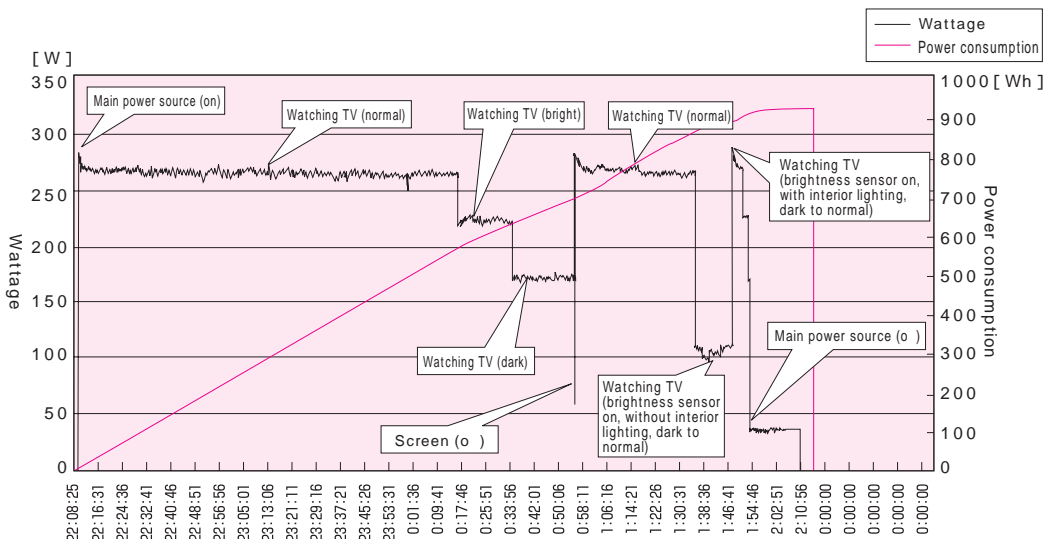

Fig. Changes in wattage of LCD TV (46") according to brightness of surroundings
Year manufactured: 2006; rated wattage: 288 W; remote controller standby power consumption: 0.1 W

5

Chapter 5 Energy-efficient Equipment Technology (Elemental Technology Application Method 3)

3) Hot water heated toilet seats

Table 6 below shows the energy-efficient device classification for hot water heated toilet seats using the power consumption of the instant boiling type as the standard (Class 0).

Table 6 Energy-efficient device classification for hot water heated toilet seats

Device classification	Method	Annual power consumption	Energy reduction
Class - 1	Hot water storage type	350 kWh or more	- 100 kWh (increase)
Class 0	Instant boiling type	200 - 350 kWh	Standard
Class 1	Instant boiling type with timer	Less than 300 kWh	50 kWh

* Based on results of actual measurements conducted during validation experiment.

- Energy-efficient technologies available for hot water heated toilet seats include “instant toilet seat “keep-warm” function”, “instant warm washing water”, “energy-efficient timer”. The “energy-efficient timer” allows the user to set periods of time (such as late-night hours) when the device is not in use and automatically shuts off the heater for the toilet seat and the warm water, which leads to energy efficiency.

4) Electric hot water pots

Table 7 below shows the energy-efficient device classification for electric hot water pots using the power consumption of the regular boiling and “keep-warm” type as the standard (Class 0).

Table 7 Energy-efficient device classification for electric hot water

Device classification	Type	Annual power consumption	Energy reduction
Class 0	Regular	240 kWh	Standard
Class 1	No “keep-warm” function (consecutive boiling)	Approx. 70 kWh	170 kWh
Class 2	Thermos	Approx. 70 kW	170 kWh

* Based on catalog values with estimated average of 8 hours of daily use.

- Energy-efficient technologies available for electric hot water pots include “improved insulating performance “thermos” and “keep-warm function at a lower temperature”. It is also recommended to use a “consecutive boiling” type electric hot water pot without “keep-warm” function that boils only the required amount of water when necessary. Pots with high insulating performance, on the other hand, reduce energy consumption by keeping the water warmer longer and requiring less re-boiling.

5) Washing machines

Table 8 below shows the energy-efficient device classification for washing machines using the power consumption of a product manufactured in 1997 without inverter control as the standard (Class 0).

Table 8 Energy-efficient device classification for washing machines

Device classification	Type	Annual power consumption	Energy reduction
Class 0	No energy-efficient design	85 kWh	Standard
Class 1	Inverter	17.5 kWh	67.5 kWh

* Based on results of actual measurements conducted with average of 4 kg of daily washing.

- Energy-efficient technologies available for washing machines include “inverters” and “zero standby power consumption”.

2 Consumer electronics affected by room temperatures and other factors

Some consumer electronics such as televisions and videocassette players are not affected by the room temperature or the water temperature while others such as refrigerators and electric hot water pots are greatly affected by them (Table 8).

Using refrigerators as an example of a consumer electronics device affected by the room temperature, Table 3 shows the difference in the effect of the room temperature on energy-efficient refrigerators and standard-type refrigerators. Energy-efficient type refrigerators were shown to be somewhat resistant to the effect of the room temperature; however, its effect on standard-type refrigerators available in 2000 was significant as the difference in power consumption was 2.5 times greater between 20°C and 30°C.

Bear in mind that ways to minimize the effect of the room temperatures on consumer electronics are usually not presented in catalogs. Furthermore, the annual power consumption figures indicated in catalogs are generally calculated using the measurement standards established by JIS. The actual power consumption may vary depending on conditions such as how the device is used.

Table 9 Effect of temperatures and other factors on consumer electronics

Examples of devices affected by room temp. and other factors	Refrigerators, electric hot water pots, hot water heated toilet seats, dishwashers, and clothes dryers
Example of devices not affected by room temp. and other factors	TVs, videocassette players, DVD players, computers, vacuum cleaners, mini stereos, radio/CD and cassette players, kitchen hoods, and washing machines

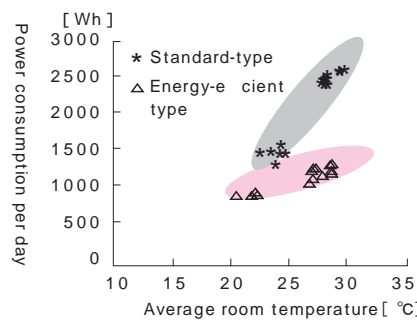

Fig. 3 Effect of room temperature on refrigerators (energy-efficient type and standard-type)

3. How to minimize effect of room temperature and other factors

Minimizing the effect of the room temperature on these consumer electronic devices can lead to energy efficiency.

1) Refrigerators

Refrigerators, one of the biggest sources of power consumption, should be placed at a location away from direct sunlight where air circulates freely. It is advisable to avoid placing a refrigerator near a stove where the air temperature tends to be high. It may also be effective to ensure air circulation by letting the outside air come in to keep the room temperature as low as possible when no one is home during the summer since the room temperature in such a situation tends to get extremely high.

Furthermore, when the door of the refrigerator is opened and closed, it lets in the warm air around the refrigerator. To minimize the effect of this, one should avoid opening the door unnecessarily. Generally speaking, even when the duration of the time that the door was open is the same, energy consumption increases when the door is opened more frequently.

2) Hot water heated toilet seat

When the room temperature of the bathroom is low, the power consumption by the hot water heated toilet seat increases. It is thus effective to improve the insulating performance of the house so as to increase the room temperature of an unheated bathroom.

3) Electric hot water pot

Similar to hot water heated toilet seats, the power consumption by electric hot water pots increases when the room temperature is low. In this case as well, it is effective to improve the insulating performance of the house so as to increase the room temperature.

5

Key Point

Comparison of annual power consumption by consumer electronics according to region

- A difference in annual power consumption by refrigerators and hot water heated toilet seats was found between the warm region and the cold region (Table).
- The table uses a standard-type device employed in a warm region (Ibaraki) as 100%.

Table: Comparison of annual power consumption by refrigerators and hot water heated toilet seats

Region	Annual average temp.	Refrigerators		Hot water heated toilet seat	
		Standard	Energy-efficient	Standard	Energy-efficient
Okinawa	22.7 °C	115.4%	60.5%	87.1%	74.4%
Ibaraki	15.3 °C	100.0%	54.5%	100.0%	82.4%
Aomori	10.3 °C	94.5%	51.2%	112.4%	89.4%

5.6.4 Estimating Running Cost of Adopting High-efficiency Consumer Electronics

For consumers, energy saving effects achieved by replacing their consumer electronics are understood in terms of saving in the running cost. By making it easier for them to become interested in the issue of running cost and to research on their own, we can create consumers who are more aware of energy efficiency and who will actually take action to improve energy efficiency. The following is a simple way to calculate running cost and how to interpret the results.

1. Calculating running cost

The formula for calculating the annual power consumption and running cost of consumer electronics when in use are as follows.

$$E = E_r \times T_r + E_s \times T_s$$

E: Annual power consumption (Wh)

E_r: Wattage when in use (W) Determine using info in catalog

E_s: Standby power consumption (W) Determine using info in catalog

T_r: Hours in use per year (h) Estimate based on lifestyle

T_s: Hours on standby per year (h) Estimate based on lifestyle

$$C = E \times P$$

C: Annual running cost (yen)

P: Electricity price (yen/kWh) normally set at 21 yen/kWh (excluding tax)

To calculate the annual running cost accurately, it is necessary to first obtain power consumption by the season and the time of day, as the electricity price may vary according to the season or the time of day in some electricity contracts. However, if comparing two or more devices of the same type (e.g. comparing two televisions), the variance in the electricity price depending on the season or the time of day would also be the same. In this case, the standard price of 21 yen/kWh (excluding tax) can easily be used.

2. How to interpret cost reduction effect when replacing devices

The cost reduction effect for replacing consumer electronics is a combination of the initial cost and the running cost.

Table 4 shows the effect of replacing devices. When the device is not replaced, an electricity bill of 25,000 yen is incurred every year. In this example, if the device is replaced in 2005, although an initial cost of 100,000 yen is incurred, the electricity bill is reduced to 5,000 yen annually and the accumulated cost is reversed after 2010.

In this example, the initial cost was recouped in five years; however, the number of years it takes to recoup the initial cost would depend heavily on the amount of the initial cost and the difference in electricity bill after-

wards. If the initial cost was high or the saving in annual electricity cost was small, the number of years to recover the cost will increase.

To maximize the effect of replacing devices, these two points need to be taken into consideration.

If comparing prime or priority consumer electronics, annual power consumption shown on energy-efficient device classification (Tables 4 – 8) can be used as a reference.

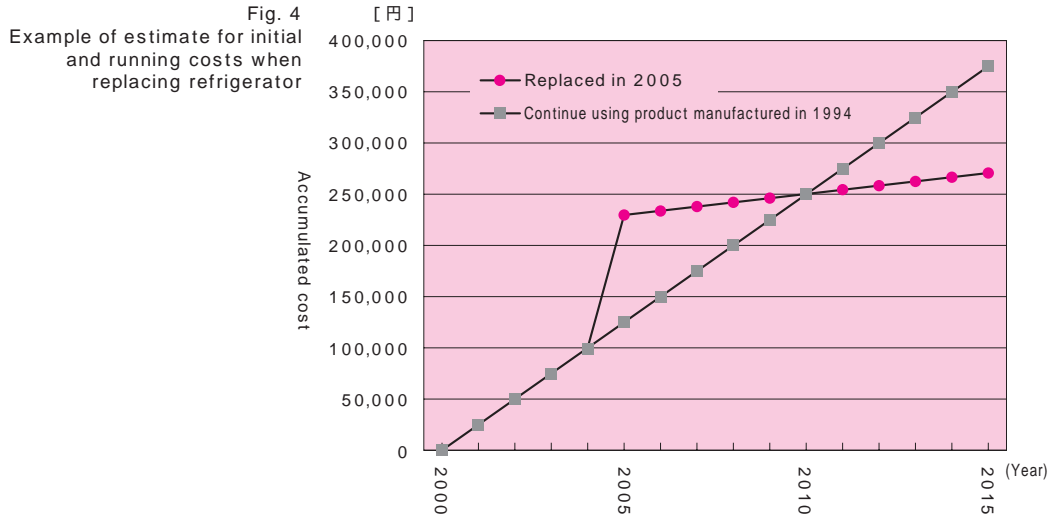

Conditions for cost estimation when replacing 460 L refrigerator
 (Electricity bill estimated when replacing product manufactured in 1994 with most energy-efficient product available in November 2004)
 Estimated annual power consumption by product manufactured in 1994: 1,130 kWh
 Estimated annual power consumption by product manufactured in 2004: 200 kWh
 (Estimated results by the 13th Energy Conservation Awards (2002) for Home Electronics "Energy-efficient refrigerator")
 Estimate based on power cost of 21 yen/kWh (excluding tax). Purchase cost was the suggested retail price at the time of purchase.

Comment Evaluation by public rating agencies as standard

Information regarding energy saving initiatives including the energy saving labeling system as well as product information can be found on the website of the Energy Conservation Center, Japan (<http://www.eccj.or.jp/>) along with consumer electronics manufacturers' websites. If detailed consideration of these data seems too daunting, one can still expect to achieve a certain degree of energy saving effect by selecting products based on the labeling system mentioned below and other similar tools.

The energy-efficiency labeling system was established in August 2000 mainly targeting air conditioners and refrigerators. As shown in Table below, as of February 2007, sixteen devices are displaying the label. All of the devices below are designated as "specified appliances" based on the Energy Conservation Law and account for a significant portion of household energy consumption.

Table Devices displaying labels (as of February 2007)

Air conditioners, refrigerators, freezers, fluorescent lighting devices, televisions, space heaters, gas cooking appliances, gas water heaters, oil water heaters, electric toilet seat, transformers, electric calculators, magnetic disk unit, rice cookers, microwave ovens, and DVD recorders.

Fig. Display logo for energy saving labeling system

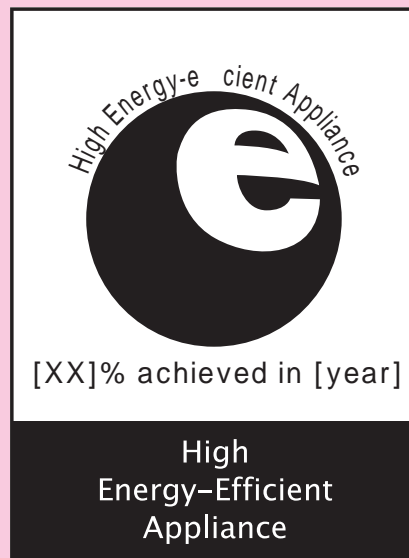

The simple label above can be displayed on a device.

5

Chapter 5
Energy-efficient
Equipment Technology
(Elemental Technology
Application Method 3)

5.7 Treatment and Efficient Use of Water and Kitchen Waste

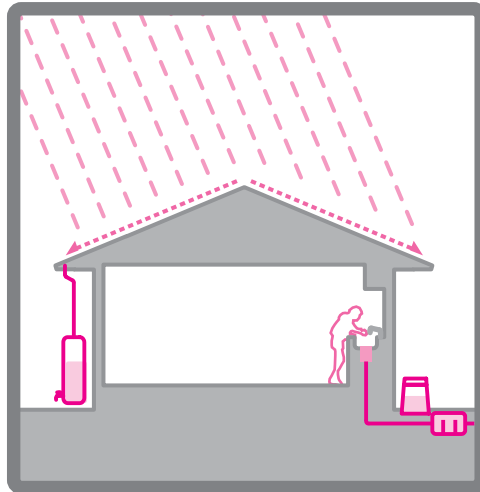

Effective use of water as well as efficient treatment technologies for wastewater and kitchen waste help us reduce waste and save water in cities and buildings. These also lead to the protection of our water resources.

Making efficient use of appropriate technologies according to the site conditions such as urban or suburban will help reduce the CO₂ emissions.

5.7.1 Purpose and Key Points of Treatment and Efficient Use of Water and Kitchen Waste

- Adopting water saving devices in rooms such as toilets, bathrooms, kitchens and washing rooms will reduce not only water usage, but also the energy required to treat, supply and heat the water.
- Using rainwater or reusing wastewater for watering plants or flush water can reduce water usage. Watering plants is especially effective as it can reduce the energy required for space cooling or can provide a cooling sensation by reducing the temperature of the surrounding area through the evaporation cooling effect.
- Adopting a rainwater seepage pit improves the habitat environment for the plants on site. It also reduces the concentration of drainage load into the public sewage system when torrential rain occurs, which helps minimize drainage flooding.
- In areas without public sewage systems, advanced wastewater treatment provided by an advanced combined treatment septic tank makes underground seepage of treated water possible, which reduces the impact on the aquatic environment.
- Adopting composting, kitchen waste disposers, and disposer wastewater treatment systems is effective in reducing the energy required for garbage collection, transport and incineration as it reduces the amount of kitchen waste produced. Reducing the amount of kitchen waste is also helpful in terms of the sanitary condition of the garbage collection site and other waste problems.

Fig. 1
Overview of treatment
and efficient use of water
and kitchen waste

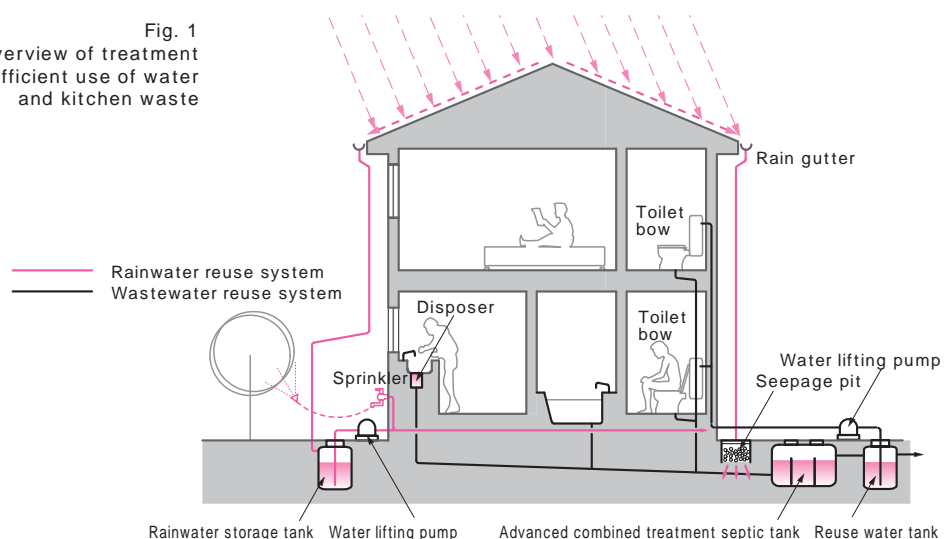

5.7.2 Target Levels and Methods for Treatment and Efficient Use of Water and Kitchen Waste

- Methods for effective use of water and efficient treatment of wastewater and kitchen waste are: water saving devices, rainwater and wastewater reuse systems, rainwater seepage pits, advanced wastewater treatment technology in areas without public sewage systems, and efficient kitchen waste treatment technology.
- Among those methods mentioned above, only water saving devices have clearly set target levels at this point in time.
- Detailed explanations are provided for each method in “5.7.4 Methods of Treatment and Efficient Use of Water and Kitchen Waste”.

1. Using water saving devices (Method 1)

The four types of water saving devices presented here are toilet bowls, hardware for domestic cold and hot water faucets, showerheads, and washing machines. Note that the capacity of these devices varies greatly depending on the time period they were sold. Following target levels 1 and 2 were established based on the difference in water saving rate by the time period (Table 1).

The water saving rate is defined as follows

$$\text{Water saving rate} = \frac{\text{Water usage by device commercially available in 1990s} - \text{water usage by device of each level}}{\text{Water usage by device commercially available in 1990s}} (\%)$$

Table 1 Target levels for using water saving device

Target level	Time period when device was sold	Water saving rate
Level 0	Commercially available in 1990s	0
Level 1	Commercially available in 2000	10 20%
Level 2	Commercially available in 2004	30 40%

2. Other methods

There are no target levels established for rainwater and wastewater reuse systems, rainwater seepage pits, advanced wastewater treatment technology for areas without public sewage systems, or efficient kitchen waste treatment technology. The following section however provides a description of each method. Although qualitative in nature, their effectiveness has been confirmed. Adopting these methods as much as possible will therefore result in reducing energy consumption as well as environmental impact.

1) Adopting rainwater and wastewater reuse system (Method 2)

The issue associated with this system is the sanitation control within the rainwater and wastewater tank. Large buildings such as office buildings can adopt a cutting-edge system to deal with the issue; however, it is advisable to adopt this system for home use within a range that does not cause any sanitation problems. This document presents the following two types of this method (Table 2).

Table 2 Types of rainwater and wastewater reuse system

Type	Purpose	Description
Type 1	For watering plants	Install rainwater storage tank
Type 2	For watering plants + flush water for toilets	1. Rainwater storage tank + water lifting pump or 2. Rainwater storage tank + water lifting pump + advanced combined treatment septic tank

5

Chapter 5 Energy-efficient Equipment Technology (Elemental Technology Application Method 3)

Glossary: BOD
BOD stands for “Biochemical Oxygen Demand”, which is an index that expresses the degree of water contamination by organic matter.

Glossary: T-N and T-P
T-N and T-P express the amount of nutrient salts, total nitrogen and total phosphorous respectively. In a closed body of water, plankton and aquatic plants thrive when the amount of these nutrient salts increases. This will in turn cause problems such as algal bloom, red tide, and blue tide. Furthermore, nitrogen infiltrating into the underground water will cause contamination from sulfuric acid.

2) Adopting rainwater seepage pit (Method 3)

Using planting ground and paving on the site through which rainwater can seep reduces the temperature of the surroundings as well as the excessive wastewater load on the public sewage system during torrential rain. Moreover, adopting a rainwater seepage pit, into which the rainwater on the roof surface flow, will further enhance its effect. This document covers the following three types of this method (Table 3).

Table 3 Types of rainwater seepage pits

Type	Purpose	Description
Type 1	Rainwater treatment	<ul style="list-style-type: none"> Allows rainwater to run off from roof surface. Covers site with impermeable material.
Type 2		<ul style="list-style-type: none"> Treats rainwater from roof surface by means of rainwater seepage pit. Covers site with impermeable material.
Type 3		<ul style="list-style-type: none"> Treats rainwater from roof surface by means of rainwater seepage pit. Covers site with permeable material.

3) Adopting advanced wastewater treatment technology (Method 4)

In areas without public sewage systems, septic tanks play an important role in aquatic environmental protection. The appropriate treatment performance should be selected based on factors such as the condition of the area’s aquatic environment, wastewater reuse, and whether or not underground seepage is required. This document discusses the following three types of this method (Table 4).

Table 4 Method of advanced wastewater treatment technology

Type	Purpose	Description
Type 1	Wastewater BOD treatment	<ul style="list-style-type: none"> Combined treatment septic tank BOD in treated water: 20 mg/L or less
Type 2	Wastewater BOD treatment, wastewater nitrogen treatment	<ul style="list-style-type: none"> Advanced combined treatment septic tank BOD and T-N in treated water: 20 mg/L or less
Type 3	Wastewater BOD treatment, advanced nitrogen (and phosphorous if necessary) treatment	<ul style="list-style-type: none"> Advanced combined treatment septic tank BOD and T-N in treated water: 10 mg/L or less Using additional devices, T-P: 1 mg/L or less

4) Adopting efficient kitchen waste treatment technology (Method 5)

The appropriate method to reduce and recycle the kitchen waste a household produces can be selected from among several options according to the site condition and the family lifestyle. This document presents the following three types of this method (Table 5).

Table 5 Types of efficient kitchen waste treatment technology

Type	Purpose	Description
Type 1	Kitchen waste recycling and reduction	Composting
Type 2		Kitchen waste disposer for home use
Type 3		Disposer wastewater treatment system

5.7.3 Steps for Considering Treatment and Efficient Use Technology for Water and Kitchen Waste

1. Steps to consider for treatment and efficient use technology for water

- Verify whether or not any water saving devices have been installed where either clean water or reuse water is used.
- Select the appropriate system for reusing rainwater and wastewater so as not to run the system at an unreasonable capacity.
- Verify by-laws and consider the influence on the soil when adopting a rainwater seepage pit.

Step 1 Verifying and considering lifestyle and area conditions

- 1) Consider where to place water saving devices (convenience and effectiveness)
- 2) Consider the possibility of the stored water freezing and where to place the tank.
- 3) Verify whether or not the area has a public sewage system.
- 4) If there is no public sewage system, verify whether or not removal of nitrogen or phosphorous is required for the protection of the water source area or closed bodies of water and other water-related areas. Verify also whether or not underground seepage of wastewater is required.
- 5) Calculate the amount of rainwater based on the area of the roof.
- 6) Calculate the required amount of water for watering plants and toilet flush water.
- 7) Consider whether or not a rainwater seepage pit is required or its installation possible (in accordance with by-laws and other ordinances).

Step 2 Determining system to adopt

- 1) Determine the water saving devices to adopt.
- 2) Determine the capacity of the storage tank and its installation location.
- 3) Determine the location and other aspects of the reuse water faucets.
- 4) Determine the specifications and the location of the rainwater seepage pit.
- 5) If there is no public sewage system, determine the treatment performance of the septic tank and the intended use for the treated water.

2. Steps to consider for treatment and efficient use technology for kitchen waste

- Consider which type of system to adopt from among composting, kitchen waste disposers for home, and the disposer wastewater treatment system.

Step 1 Verifying and considering lifestyle and area conditions

- 1) Verify whether or not the area has a public sewage system. (Especially, if the area has a public sewage system, verify whether or not installation of a disposer wastewater treatment system is permitted.)
- 2) Verify the size of the garden and the conditions of use. (Verify whether or not it is possible to adopt composting.)
- 3) Consider whether or not compost can be used. (Verify whether or not it is possible to adopt composting.)

Step 2 Determining system to adopt

- 1) Make a provisional decision based on the conditions in Step 1.
- 2) Consider factors such as power consumption after adopting the system. (The condition for adopting kitchen waste disposer.)
- 3) Verify the user-friendliness of the system and whether or not local authorities offer subsidies.
- 4) Verify that the system is suited for the intention (user-friendliness) of the occupants or the contractor.
- 5) Determine the system to adopt.

5

5.7.4 Methods of Treatment and Efficient Use for Water and Kitchen Waste

Method 1 : Using water saving devices

- Water saving devices are easy to adopt as they can be effective even when used on their own. Note that effects vary greatly from one device to another, so care is required when selecting one.
- Four water saving devices are presented here: toilet bowls, hardware for domestic cold and hot water faucets, showerheads, and washing machines. Table 6 shows the capacity (water usage and other characteristics) and the specifications of each device by target levels and rooms.

Table 6 Setting levels for water saving devices

Device	Toilet bowls	Hardware for domestic cold and hot water		Showerheads	Washing machines
	Toilet	Bathroom	Washing room/Kitchen	Bathroom/ Washing room	Various locations
Evaluation index	Quantity of flush water (L)	Water saving function/ temperature adjustment	Water saving function/ temperature adjustment	Water saving function	Quantity of washing water (L)
Level 0	13	Two-valve mixer faucet	Two-valve mixer faucet	No water saving function	200
Level 1	12 9	Thermostatic mixer faucet	Single-lever mixer faucet	Shower head w/ shut-off	150
Level 2	8 6		Automatic faucet		80

* Values indicated for each level are to be used as reference since the way devices are used by occupants influences them considerably in real life.

1. Toilet bowls

Toilet bowls are categorized as shown in Table 7 based on their flush method and the quantity of flush water. The table shows the JIS standards and the standard values for Quality Housing Components Certification (BL-standards) by the Center for Better Living. From the point of view of water saving, ones that require less flush water were deemed superior.

However, it is important to design the system to smoothly eliminate waste and toilet paper by ensuring that enough flush water is provided and establishing an appropriate piping slope (See Table 12 on p.334).

In recent years, models with no low tank or super water saving toilet bowls with roughly 6 L of flush water have become increasingly popular; however, before adopting these types of toilet bowls, it is necessary to secure enough water pressure (dynamic water pressure) for the former and to ensure that an appropriate length of piping and number of bends in the piping are in place for the latter.

Table 7 Types of toilet bowls and standards for quantity of flush water

Types of toilet bowls	Quantity of flush water (L)	
	JIS Standards	BL-standards
Washout toilets and washdown toilets	11	N/A
Washout toilets (water saving) and washdown toilets (water saving)	8	≤9.5
Washdown toilets (super water saving)	N/A	Large flush ≤6.5, small flush ≤5
Siphon toilets and siphon jet toilets	13	≤13
Siphon toilets (water saving)	9	N/A
Siphon vortex toilets	N/A	≤18

2 Hardware for domestic cold and hot water faucet

Compared with two-valve mixer faucets, thermostatic mixer faucets waste less water as they allow the user to set or adjust the temperature, which in turn further enhances the energy saving effect.

Automatic faucets detect approaching hands by their sensor and open and close the tap, which reduces the amount of wasted water when the tap is inadvertently left open. Furthermore, this type is more sanitary as hands do not touch the faucet.

Fig. 2
Hardware for domestic cold and hot water



Thermostatic mixer faucet

Two-valve mixer faucet

3. Showerheads

Recently, new types of showerheads with verified water saving effect have become commercially available. These showerheads are equipped with a shut-off mechanism (shut-off type) that allows the user to shut off the water at the showerhead. Fig. 4 shows the water usage per shower by this type of device. The shut-off type is shown to have high water saving effect regardless of the season.

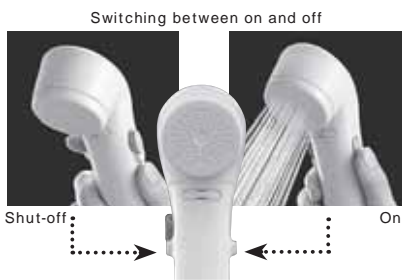

Fig. 3 Example of showerhead with shut-off mechanism

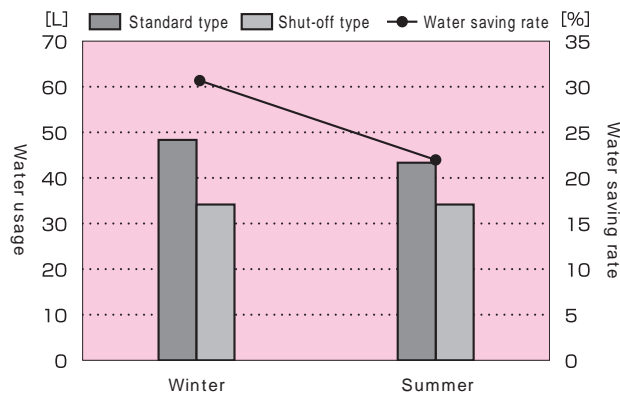

Fig. 4 Example of water usage experiment results (amount of water used per shower) using standard and shut-off type showerheads

4. Washing machines

There are two types of water saving function with which washing machines may be equipped: that which uses the remaining hot water from a bath, and that which saves water when washing. Virtually all manufacturers' washing machines are compatible with the former; however, note that the remaining hot water should not be used if it appears dirty and the bathtub needs to be kept clean after each use.

Water saving technologies available for washing machines include "high-concentration detergent circulation" and "water-saving beat wash"; however, each manufacturer has come up with their own unique methods. Comparing water usage is difficult as it varies depending on how the washing has been done with each option; nevertheless, note that one product saved 60% of water when performing 8 kg of washing on the regular setting.

5

Chapter 5
Energy-efficient
Equipment Technology
(Elemental Technology
Application Method 3)

Method 2 : Adopting rainwater and wastewater reuse system

- Reusing rainwater and wastewater requires a storage tank for rainwater and reuse water. Furthermore, the use for reuse water is rather limited due to its water quality. The effect of this system also depends heavily on the site conditions. It is therefore essential to select a type that is suitable for these conditions.
- There are several types of rainwater and wastewater reuse systems. One is equipped with a simple rainwater tank to be used for watering plants and other similar tasks while another is equipped with an advanced combined treatment septic tank to provide the treated water to be used as toilet flush water. Table 8 shows an overview of some of these systems.

Table 8 Rainwater and wastewater reuse systems and their characteristics

Type	Diagram	Type	Characteristics
Type 1		Rain gutter + rainwater storage tank	<ul style="list-style-type: none"> • Power is not required for waste supply. • Easy maintenance. • Low cost.
Type 2		Rain gutter + rainwater storage tank + water lifting pump	<ul style="list-style-type: none"> • Requires water lifting pump. • Can frequently run out of rainwater. Add clean water to tank when this occurs.
		Rain gutter + rainwater storage tank + water lifting pump + advanced combined treatment septic tank	<ul style="list-style-type: none"> • Requires water lifting pump. • Efficient use by combining rainwater and wastewater. • Can be combined with disposer wastewater system. • Almost never runs out of water. Excess reclaimed wastewater is discharged. The excess is also suitable for underground seepage thanks to its advanced treatment.

Key Point

Points of caution for reusing rainwater and wastewater

- 1) Although the water should not cause any health problems as it goes through chlorine cleaning, the water quality may deteriorate due to lack of maintenance. Ensure that children do not accidentally swallow or inhale spray water while playing with it.
- 2) If storing water in the rainwater storage tank, sterilize it with chlorine (add a disinfectant agent). Check the water quality when necessary.
- 3) Perform maintenance on the suction opening of the water lifting pump to prevent sediment from clogging it. The screen also requires frequent cleaning.

Comment Wastewater reuse

Generally speaking, reclaimed wastewater is used for purposes for water quality 4 or lower indicated on the table below. In a home, those activities include toilet flush water and watering the garden. When using reclaimed wastewater, a water quality check should be performed when necessary. If using chlorine disinfectant,

check to ensure that the system has not run out of the disinfecting agent.

Furthermore, if using reclaimed wastewater for watering the garden, ensure that people do not inhale the water's spray to prevent the spread of Legionella.

Table: Types of water use and water quality

Water quality level	Purposes of use	Remarks
High ↑ ↓ Low	1 Drinking and cooking	Sustenance, oral contact
	2 Washing hands and face, bathing, pools	Maintaining sanitation and comfort, occasional oral contact, skin contact (direct)
	3 Washing clothes	Maintaining sanitation and comfort, bodily contact (indirect), hand contact
	4 Cleaning, washing cars, fire prevention, extinguishing fire (individual cooling)	Maintaining sanitation, comfort and safety, hand contact
	5 Toilet flushing, sprinkling the garden, ponds, fountains	Maintaining sanitation and comfort, hand contact, seeing, hearing

Comment Water saving effect of rainwater storage tank

Figure on the right shows the changes in reuse rate according to the capacity of rainwater storage tank based on the rainfall in Tsukuba City in 2004. The reuse rate is shown to be 40% using a mere 0.1m³ storage tank. Although the amount of rainfall varies greatly depending on the region or the year, it can be said that this system can provide a certain degree of effect.

Calculation conditions
 Water collection area: 71.2 m²
 Amount of toilet flush water: 104 L/day

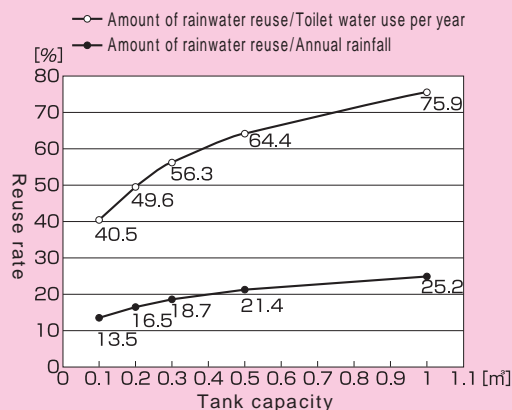

Fig. Capacity of rainwater storage tank and rainwater reuse rate

5

Chapter 5 Energy-efficient Equipment Technology (Elemental Technology Application Method 3)

Method 3 : Adopting rainwater seepage pit

- Excessive load on a public sewage system during torrential rain can be reduced by filtering it through rainwater-permeable pavement and planting soil. The effect can also be further enhanced by letting the rain from the roof surface filter through a rainwater seepage pit or infiltration trench (Fig. 5).
- One of the advantages of this method is that it prevents landslides by increasing the amount of rainwater seeping underground and providing extra water for trees lining the sidewalk and other green spaces to encourage growth. It also contributes to the natural recovery of the city's ecosystem and improves our living environment. Some other likely benefits of this method are securing underground water, reviving spring water, reducing the impact of salination of underground water, and preventing subsidence.
- Although there are some initial costs associated with the method, some local authorities provide subsidies. It is preferable therefore to enquire before making a decision whether or not to adopt the system.
- However, this system is not suitable for areas where underground water is located close to the surface or in cold regions, and may also be banned under by-laws in certain areas. It is therefore necessary to confirm the suitability with the local authorities before adopting this system.
- The capacity of the system also depends heavily on the soil's infiltration characteristics. Verify them during the ground survey so that an effective seepage pit can be installed.

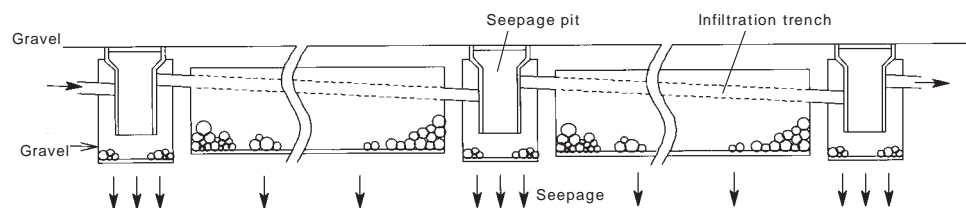

Fig. 5 Example of rainwater seepage pit on residential lot

Glossary: Infiltration rate
It expresses the amount of rainwater (mm) that can filter through per hour.

Comment Effect of rainwater seepage

What would the required infiltration rate be when filtering rainwater through rainwater-permeable pavement or planting soil?

It is accepted that a site with a capacity to filter 5 mm of rainwater per hour can filter approximately 80% of the rainfall. An example of a site with this capacity is shown below.

The areas into which rainwater can seep are (1) and (2) only, which can secure an infiltration rate of 5 mm/hr. Although the infiltration

rate of the soil can vary depending on the type of soil, even soil with a low infiltration rate was able to fulfill the above condition.

A single-family home can use rainwater seeping pavement for the garage and planting soil for the garden to achieve similar effect. Doing so will also help create cool breeze during the summer or in-between seasons and improve the living environment.

Example of site with capacity to filter roughly 5 mm of rainwater/hr

Site area: 2,682 m², Building area: 1,175 m² (multi-family complex)

(1) Planting ground area: 536 m² (20% of site area)

(2) Parking area: 700 m² using water-permeable asphalt concrete

(3) Other: 271 m² (bicycle rack area, garbage disposal area and building entrance)

Method 4 : Adopting advanced wastewater treatment technology

- In areas without public sewage systems, septic tanks play an important role in protecting the aquatic environment. In these areas, it is prohibited to install single treatment septic tanks and the use of combined treatment septic tanks is mandatory. Especially in water source areas and near closed bodies of water, removal of organic pollution load expressed by BOD (Biochemical Oxygen Demand) as well as nitrogen (T-N) and phosphorous (T-P) is required. To do so, installing an advanced combined treatment septic tank equipped with sophisticated nitrogen and phosphorous removal capabilities is necessary.
- Furthermore, if the treated water from the septic tank does not have a specific effluent destination and infiltrates into the underground water, nitrogen in the treated water needs to be sufficiently removed to protect the underground water from pollution. This scenario also requires an advanced combined treatment septic tank.
- Table 9 shows the types of advanced wastewater treatment technology and their characteristics.

Table 9 Types of advanced wastewater treatment technology and their characteristics

Type	Description	Characteristics
Type 1	Combined treatment septic tank	<ul style="list-style-type: none"> • BOD in treated water 20 mg/L or less • Not suitable near closed bodies of water or water sources • Treated water not suitable for seeping into underground water
Type 2	Combined treatment septic tank for nitrogen removal	<ul style="list-style-type: none"> • BOD and T-N in treated water 20 mg/L or less • Effective as measure to prevent pollution near closed bodies of water and water sources • Treated water not suitable for seeping into underground water
Type 3	Advanced combined treatment septic tank	<ul style="list-style-type: none"> • BOD and T-N in treated water 10 mg/L or less. If necessary, T-P should be 1 mg/L or less (done w/ additional devices) • Effective as measure to prevent pollution near closed bodies of water and water sources • Treated water suitable for seeping into underground water

5

Chapter 5
Energy-efficient
Equipment Technology
(Elemental Technology
Application Method 3)

Method 5 : Adopting efficient kitchen waste treatment technology

- When considering kitchen waste treatment technology for home use, important factors need to be verified such as the occupants' lifestyle, the site conditions (especially how complete the sewage system is), and how frequently the generated compost will be used. Additionally, consider the convenience and the initial as well as the running cost of the system equipment to determine whether to adopt the system or not.
- Table 10 shows the types of kitchen waste treatment for home use and their characteristics.

Fig. 10 Types of kitchen waste treatment and characteristics

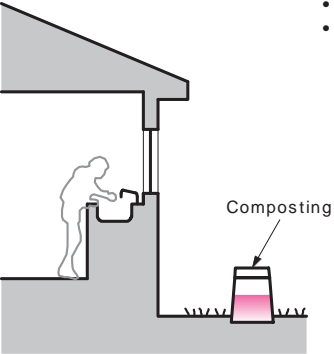
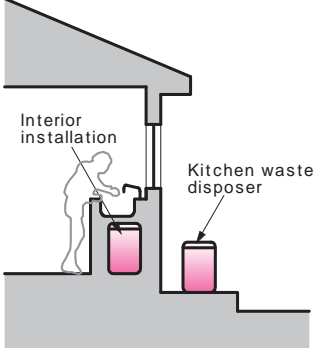
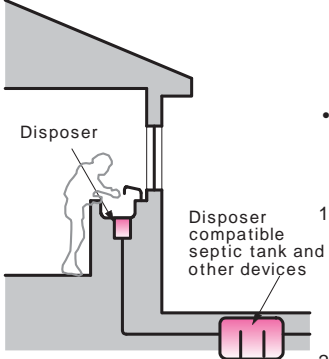
Type	Description	Image	Conditions for adopting system	Characteristics
Type 1	Composting		<ul style="list-style-type: none"> • Compost can be used. • Can secure installation location where issues such as odor or unsanitary pest infestations can be dealt with if they occur. 	<ul style="list-style-type: none"> • Least expensive. • Some local authorities provide subsidies. • Producing compost is time-consuming and labor-intensive. Depending on how frequently compost is used, two or three containers may be needed. • Requires soil for installation location.
Type 2	Kitchen waste dispose		<ul style="list-style-type: none"> • Can secure installation location for kitchen waste disposer where odor is not issue. • Requires power supply. 	<ul style="list-style-type: none"> • Some local authorities provide subsidies. • Requires ventilation for odor produced by treatment. • Install at location where odor does not blow back. • Final product can either be compost or dry waste. • Incurs power consumption of roughly 7,500 yen per year.
Type 3	Disposer wastewater treatment system		<ul style="list-style-type: none"> • In areas with public sewage systems, approval from system manager is required for installation of disposer wastewater treatment system. • In areas without public sewage systems, one of the following must apply: <ol style="list-style-type: none"> 1) Treated water from disposer wastewater treatment system flows into advanced combined treatment septic tank; 2) Disposer-compatible septic tank is installed. 	<ul style="list-style-type: none"> • Comprising of disposer, wastewater piping and wastewater treatment device. • Confirm approval of and instruction from local authorities when adopting system. • Requires sludge treatment and possibly other cleaning of wastewater treatment device. • Requires installation space and some construction work for wastewater treatment device.

1. Composting

- When adopting composting, certain factors need to be taken into consideration. In other words, the site where the compost produced will be used, its environment and the occupants' lifestyle all need to be suitable for composting.
- It is preferable to secure a sufficiently large space (soil) for installing two or three compost containers. Furthermore, careful attention must be paid to the environment of the surrounding area of the installation site since issues such as odor and unsanitary pest infestations may arise during the advanced stage of fermentation.
- As compost containers are installed outside, some degree of inconvenience is expected when disposing kitchen waste. It is preferable, therefore, to secure a safe pathway for doing so.
- Some local authorities provide subsidies for waste reduction measures. Inquire regarding the amount provided and the application process at local offices.

2. Kitchen waste disposer for home use

- There are generally two types of kitchen waste disposers for home use. One called the "dry-type" produces dried waste to be disposed of and the other, the "bio-type", produces compost (Table 11). Careful consideration is required when adopting a disposer as power consumption varies even among disposers of the same type.
- When adopting a kitchen waste disposer for home use, before determining the installation location, consider the factors such as the flow line from the kitchen, the size of the kitchen waste disposer, the position of the electric plug, and different specifications for indoor and outdoor unit. Furthermore, ventilation needs to be considered carefully even if the unit is equipped with an odor removal function.
- The method of maintenance varies from one type to another. Factors such as labor-intensity therefore need to be taken into account before making a decision.
- Similar to the compost containers, some local authorities provide subsidies for kitchen waste disposers.

Table 11 Types of kitchen waste disposers for home use and their characteristics

Treatment type	Characteristics
Dry-type	This type of disposer removes moisture in kitchen waste via evaporation through heating by means of hot air or heater. This process reduces mass of kitchen waste and prevents putrefaction. Dried residue is periodically disposed of as waste; however, it can in some cases be reused as fertilizer. Its power consumption is higher than bio-type; however, it performs treatment in short period of time and requires no material to be added such as sawdust or microorganisms.
Bio-type	This type of disposer makes use of purification function of microorganisms that decompose organic matter in kitchen waste. This process reduces mass of kitchen waste and prevents putrefaction. Residue is usually reused as fertilizer or compost. It requires user to periodically add microorganisms as well as sawdust or woodchips to maintain microorganisms.

5

3. Disposer wastewater treatment system

- A disposer wastewater treatment system comprises a disposer that crushes the kitchen waste, a piping system that transports the debris and a treatment device that treats the wastewater containing the debris. The following key points need to be taken into consideration when planning and designing a disposer wastewater system.

1) Condition of public sewage system

If the public sewage system is fully complete, an exclusive wastewater treatment system can be installed to treat the water before releasing it into the public sewage system. In areas without public sewage systems, one of the following two scenarios must apply when adopting a disposer wastewater system.

- (1) A disposer-compatible septic tank is installed to treat all wastewater.
- (2) An exclusive wastewater treatment device and an advanced combined treatment septic tank are installed so that the disposer wastewater treated by the exclusive wastewater treatment device is then further treated by the advanced combined treatment septic tank.

2) Installation location for septic tanks and other devices

When adopting a disposer, it is necessary to first confirm that there is enough space to install a disposer-compatible septic tank and an exclusive wastewater treatment device. If underground work is required, the installation location must be determined after considering the workability of the excavation work.

The space required by a septic tank used for a one- to five-person household is approximately 900 mm (depth) x 1,200 mm (width) x 1,400 mm (height) if using a kitchen-exclusive type with a disposer, and 1,300 mm (depth) x 2,500 mm (width) x 1,800 mm (height) if using a general wastewater type.

3) Piping

When planning and designing the piping, it is necessary to ensure that there is a drainage piping slope from the disposer to the disposer-compatible septic tank and then to the exclusive wastewater treatment device. Pipes may clog if the piping slope is not properly set up. As a rule, design must follow the minimum slope by pipe diameter shown in Table 12.

The wastewater pit must be an inverted pit . If the piping system is connected to a trap pit , problems such as blockage or foul odor blowing back indoors due to a broken trap may occur. (This scenario does not only apply to disposers; however, the likelihood of problems occurring is increased by the use of a disposer.)

Table 12 Slope for horizontal wastewater pipes (from SHASE-S206-2000)

Pipe diameter (mm)	Slope (minimum)
65 or less	1/50
75 and 100	1/100
125	1/150
150, 200, 250, and 300	1/200

4) Points of caution for adopting treatment device

If a mechanical solid-liquid separator is used to separate the kitchen waste to be treated, verify that the structure of the device ensures that the exhaust from the device does not have a negative impact. Shooting the exhaust from the device into the wastewater pipe will cause inconvenience to the neighbors as well as major sanitary problems due to a broken trap, foul odor blowing back indoors, and foul odor escaping from the sewage pipes. The exhaust from the device therefore needs to be released directly to the outside air so as not to cause problems resulting from foul odors.

5.7.5 Estimating Effects of Using Water Saving Devices

Table 13 shows estimates of the water saving effect as well as the energy reduction effect. The result was obtained based on the use of a water saving device (method 1) under the conditions indicated in A.

A. Trial conditions

- 1) Location: Tokyo
- 2) Family composition: Four (husband, wife and two children)
Husband (company employee); wife (homemaker); daughter (university student); son (high school student)
- 3) Daily schedule
 - (1) Toilet: large flush once per person
 small flush three times per person
 - (2) Bathing: 150 L
 - (3) Shower: once per person
 - (4) Kitchen: three times
 - (5) Washing machine: once
- 4) Water heater: conventional gas water heater

B. Estimation result of water saving and energy reduction effect

Table 13 Example of estimate of water saving and energy reduction effect by using water saving device

Room/Device		Device used before	Water saving device	Water saving amount/rate		Energy reduction amount/rate	
Toilet	Toilet bowl	Flush water = 13 L/flush	W/ large and small flush function (Quantity of flush water) Large flush = 8 L/flush Small flush = 6 L/flush	76 m ³ → 38 m ³ = 38 m ³ saved	50% less	N/A	N/A
Bathroom	Showerhead/faucet hardware	Regular shower w/ no shut-off, two-valve mixer faucet	Water saving shower w/ manual shut-off, thermostatic mixer faucet	89 m ³ → 58 m ³ = 31 m ³ saved	35% less	Gas 257 m ³ → 168 m ³ = 89 m ³ saved	35% less
	Bathtub	No shut-off at set water level (Quantity of water) Wasted water = 4.5 m ³ /year Bathtub = 150 L	W/ shut-off at set water level (Quantity of water) Waste water = 0 Bathtub = 150 L	59 m ³ → 54 m ³ = 5 m ³ saved	8% less	Gas 170 m ³ → 157 m ³ = 13 m ³ saved	8% less
Total				224 m ³ → 150 m ³ = 74 m ³ saved	33% less	Gas 427 m ³ → 325 m ³ = 102 m ³ saved	24% less

Conditions for conversion of gas consumption by domestic hot water
 $1.065 \times 10^{-4} \text{ Nm}^3/\text{kcal}$
 Domestic hot water was provided by gas heater. Gas consumption was established using heat efficiency of common gas water heater.

